



OWNER'S MANUAL

Dynamic Controller

Please read this manual carefully before operating your set and retain it for future reference.

MODEL
LKD1000

P/NO : MFL62723777



CAUTION

RISK OF ELECTRIC SHOCK
DO NOT OPEN



CAUTION: TO REDUCE THE RISK OF ELECTRIC SHOCK
DO NOT REMOVE COVER (OR BACK)
NO USER-SERVICEABLE PARTS INSIDE
REFER SERVICING TO QUALIFIED SERVICE
PERSONNEL.



This lightning flash with arrowhead symbol within an equilateral triangle is intended to alert the user to the presence of uninsulated dangerous voltage within the product's enclosure that may be of sufficient magnitude to constitute a risk of electric shock to persons.



The exclamation point within an equilateral triangle is intended to alert the user to the presence of important operating and maintenance (servicing) instructions in the literature accompanying the product.

FCC WARNING: This equipment may generate or use radio frequency energy. Changes or modifications to this equipment may cause harmful interference unless the modifications are expressly approved in the instruction manual. The user could lose the authority to operate this equipment if an unauthorized change or modification is made.

REGULATORY INFORMATION: FCC Part 15

This equipment has been tested and found to comply with the limits for a Class A digital device, pursuant to Part 15 of the FCC Rules. These limits are designed to provide reasonable protection against harmful interference when the equipment is operated in a commercial environment.

This equipment generates, uses, and can radiate radio frequency energy and, if not installed and used in accordance with the instruction manual, may cause harmful interference to radio communications.

Operation of this equipment in a residential area is likely to cause harmful interference in which case the user will be required to correct the interference at his own expense.

- A suitable conduit entries, knock-outs or glands shall be provided in the cable entries of this product in the end user.
- Caution: Danger of explosion if battery is incorrectly replaced. Replaced only with the same or equivalent type recommended by the manufacturer. Dispose of used batteries according to the manufacturer's instructions.
- Holes in metal, through which insulated wires pass, shall have smooth well rounded surfaces or shall be provided with brushings.

Warning: Do not install this equipment in a confined space such as a bookcase or similar unit.

Warning: Wiring methods shall be in accordance with the National Electric Code, ANSI/NFPA 70.

Warning: This is a class A product. In a domestic environment this product may cause radio interference in which case the user may be required to take adequate measures.

Warning: To reduce a risk of fire or electric shock, do not expose this product to rain or moisture.

Caution: This installation should be made by a qualified service person and should conform to all local codes.

Caution: To avoid electrical shock, do not open the cabinet. Refer servicing to qualified personnel only.

Caution: The apparatus shall not be exposed to water (dripping or splashing) and no objects filled with liquids, such as vases, shall be placed on the apparatus.

Disposal of your old appliance



1. When this crossed-out wheeled bin symbol is attached to a product it means the product is covered by the European Directive 2002/96/EC.
2. All electrical and electronic products should be disposed of separately from the municipal waste stream via designated collection facilities appointed by the government or the local authorities.
3. The correct disposal of your old appliance will help prevent potential negative consequences for the environment and human health.
4. For more detailed information about disposal of your old appliance, please contact your city office, waste disposal service or the shop where you purchased the product.



LG Electronics hereby declares that this/these product(s) is/are in compliance with the essential requirements and other relevant provisions of Directive 2004/108/EC, 2006/95/EC, and 2009/125/EC.

European representative :

LG Electronics Service Europe B.V.
Veluwezoom 15, 1327
AE Almere, The Netherlands
(Tel : +31-(0)36-547-8888)

IMPORTANT SAFETY INSTRUCTIONS

1. **Read these instructions.**
2. **Keep these instructions.**
3. **Heed all warnings.**
4. **Follow all instructions.**
5. **Do not use this apparatus near water.**
6. **Clean only with dry cloth.**
7. **Do not block any ventilation openings. Install in accordance with the manufacturer's instructions.**
8. **Do not install near any heat sources such as radiators, heat registers, stoves, or other apparatus (including amplifiers) that produce heat.**
9. **Do not defeat the safety purpose of the polarized or grounding-type plug. A polarized plug has two blades with one wider than the other. A grounding type plug has two blades and a third grounding prong. The wide blade or the third prong are provided for your safety. If the provided plug does not fit into your outlet, consult an electrician for replacement of the obsolete outlet.**
10. **Protect the power cord from being walked on or pinched particularly at plugs, convenience receptacles, and the point where they exit from the apparatus.**
11. **Only use attachments/accessories specified by the manufacturer.**
12. **Use only the cart, stand, tripod, bracket, or table specified by the manufacturer, or sold with apparatus. When a cart is used, use caution when moving the cart/apparatus combination to avoid injury from tip-over.**
13. **Unplug this apparatus during lightning storms or when unused for long periods of time.**
14. **Refer all servicing to qualified service personnel. Servicing is required when the apparatus has been damaged in any way, such as power- supply cord or plug is damaged, liquid has been spilled or objects have fallen into the apparatus, the apparatus has been exposed to rain or moisture, does not operate normally, or has been dropped.**



CONTENTS

INTRODUCTION.....	5	OPERATION.....	14
About LKD1000 Controller.....	5	Operation the LG DVR.....	14
Features.....	5	Operation the connected camera via the DVR.....	16
Identification of the Controller	6	Operation of the camera connected to the LKD1000 controller directly.....	16
 		Camera Control Menu	17
HOOKUP AND SETTINGS.....	8	Camera Control menu overview	17
Basic Connection Overview	8	Preset Settings.....	17
RS-485 Connection.....	9	Auto Pan Setup and Activation	23
Connecting the LG DVR.....	9	Pattern Setup and Activation	24
Connecting the PTZ Camera	10	Privacy Setup.....	25
Connecting the multiple LKD1000 controller	10	Communication Settings	26
System Operation.....	11	Camera setup	29
LKD1000 SETUP MENU.....	11	 	
Key Functions on the Setup menu	11	REFERENCE	32
Change Password.....	12	Camera Control Function	32
About DVR	12	Pan/Tilt Control	32
About Camera	13	Lens Control.....	32
Change ID Setting.....	13	Protocol Function Table	33
Auto Lock Setting	13	Specifications	34
Factory Reset.....	14		
About LKD1000.....	14		

INTRODUCTION

About LKD1000 Controller

This controller is the brand of Camera and DVR Controlling Keyboard of LG in a surveillance system. You can operate this system very easily and conveniently because of design structure based on biotechnology and various functions for users. In addition, the controller can control using the functions of the LG Camera and LG DVR system.

**The description functions used in this manual are based on LG Multix protocol.
The description functions may differ from your protocol.**

Features

The Dynamic Controller offers the following functions:

- User-friendly Graphical User Interface.
- Compatible with LG Dome Cameras, Zoom Cameras and LG DVRs.
- Joystick Control for PTZ Functions.
- Program Preset Position and Pattern Control (Memorize continuous series of Zoom In/Out, Pan/Tilt).
- Control Privacy Zone Masking of the camera.
- Easy Firmware Upgrade
(Please contact authorized service center or where you purchased to upgrade the firmware.)
- Ergonomic Design.
- Directly Control the camera connected to LG DVR by using BY-PASS function of LKD1000 controller.
- Connect maximum 16 controller by using cascade (Master 1, Slave 15)
- Support the use of multiple controllers by cascading.

Note:

The Dynamic Controller is not provided with functions to control the audio signal. Audio communication is not possible, regardless of whether audio boards are installed in the receiver.

Identification of the Controller

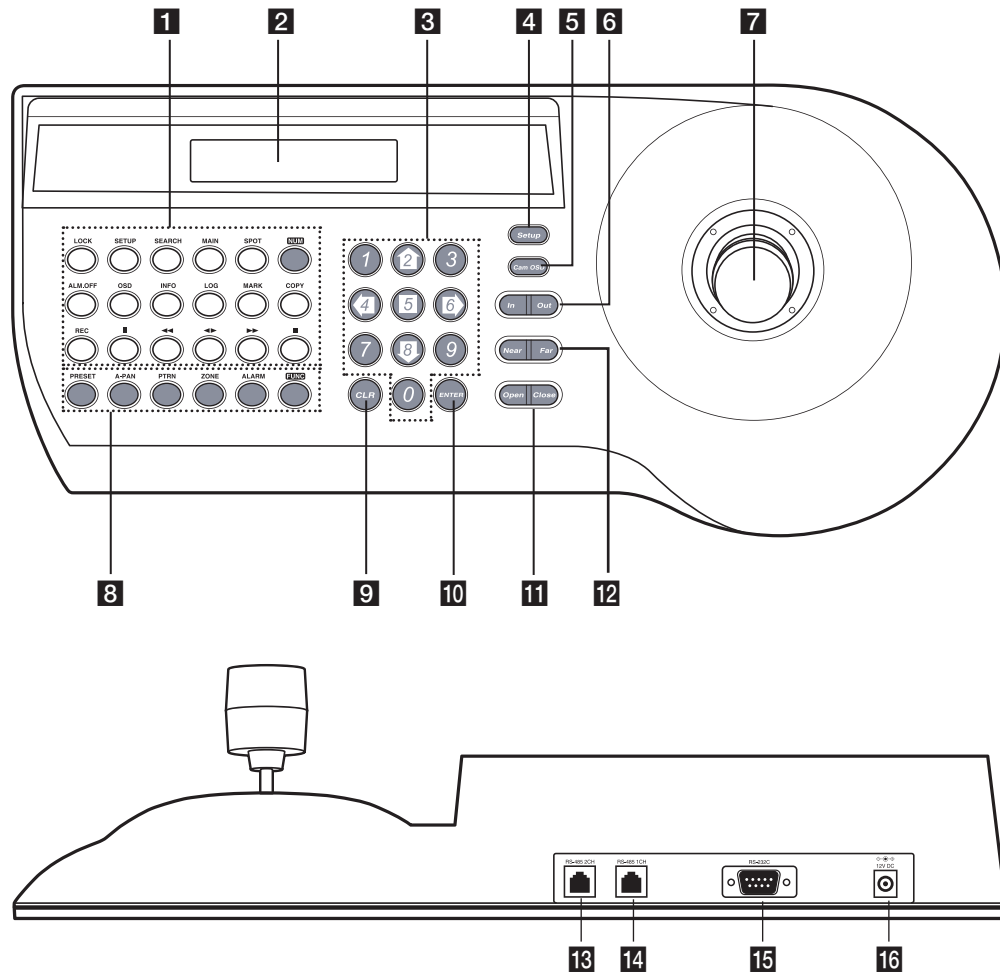

1 LG DVR Control Buttons

For details, see page 15.

2 Display Window

Displays function menus, numeric input, and system status.

3 Numeric (0 to 9) and Arrow (left/right/up/down) Buttons

Selects an option in the menu. These buttons are used for numeric input of pre-set numbers or for executing each parameter on the Controller's menu.

4 Setup Button

Opens controller's main Setup menu in the display window.

5 Cam OSD Button

Opens or closes the Camera's Setup menu on the screen.

6 In/Out Buttons

These buttons are used to zoom the camera image In (TELE) and Out (WIDE).

7 Joystick Controller

This joystick manually operates the Pan/Tilt Head and turning the joystick head to the left or right will zoom or widen the image. (The zooming level will go up or down.)

8 PTZ Camera Control Buttons

- PRESET Button
For details, see pages 17 to 23.
- A-PAN (Auto-Pan) Button
For details, see pages 23 to 24.
- PTRN (Pattern) Button
For details, see pages 24 to 25.
- ALARM Button
For details, see pages 22 to 23.
- FUNC Button
 - In the LKD1000 setup menu:
 - > FUNC + Number 0: You can adjust the brightness of the display window (4: Decrease, 6: Increase).
 - In the camera setup menu:
 - > FUNC + Number 1: If you use LG Multix Protocol, you can set the parking time to use the Auto Return function. If you stop the preset tour, the preset tour will automatically restarted after the selected park time passes.
 - > FUNC + Number 6: If you use LG Multix Protocol, press the button to select the Focus mode (Auto, Manual or PushAuto).
 - > FUNC + Number 9: If you use LG Multix, LG Multix E or LG Zoom Protocol, press the button to activate auto focus. For using this function, the camera's focus mode is set to one push auto focus mode.
 - FUNC + Number 2,3,5,7,8: These buttons are not assigned.

9 CLR (CLEAR) Button

This button is used to return to the previous menu or mode. Clears the parameter entered by numeric buttons.

10 ENTER Button

This button is used to execute the currently highlighted setting in the Setup menu.

11 Open/Close Buttons

The lens Iris is adjusted by pressing the Open or Close button.

12 Near/Far Buttons

These buttons are used to adjust the lens focus of cameras equipped with the specified lens.

13 RS-485 Data Ports (CH 2)

This port is used to connect the other LKD 1000 controller. If you want to use the multiple LKD1000 controller, connect the RS-485 1CH of the other LKD1000 controller to this port using the RS-485 cable.

14 RS-485 Data Ports (CH 1)

This port is used to exchange control data through the connected camera and/or DVR via the RS-485 cable or by connecting the master (or the other) controller.

15 RS-232C Port

This port is used only for authorized service purposes.

16 DC 12 V Input Jack (12 V DC)

Connect a DC 12 V Certified/Listed, class 2 power supply only to the DC input terminal on the back of the controller.

HOOKUP AND SETTINGS

Precautions

- The connections should be made by qualified service personnel or system installers in accordance with all local codes.
- DC 12 V can be used.

Basic Connection Overview

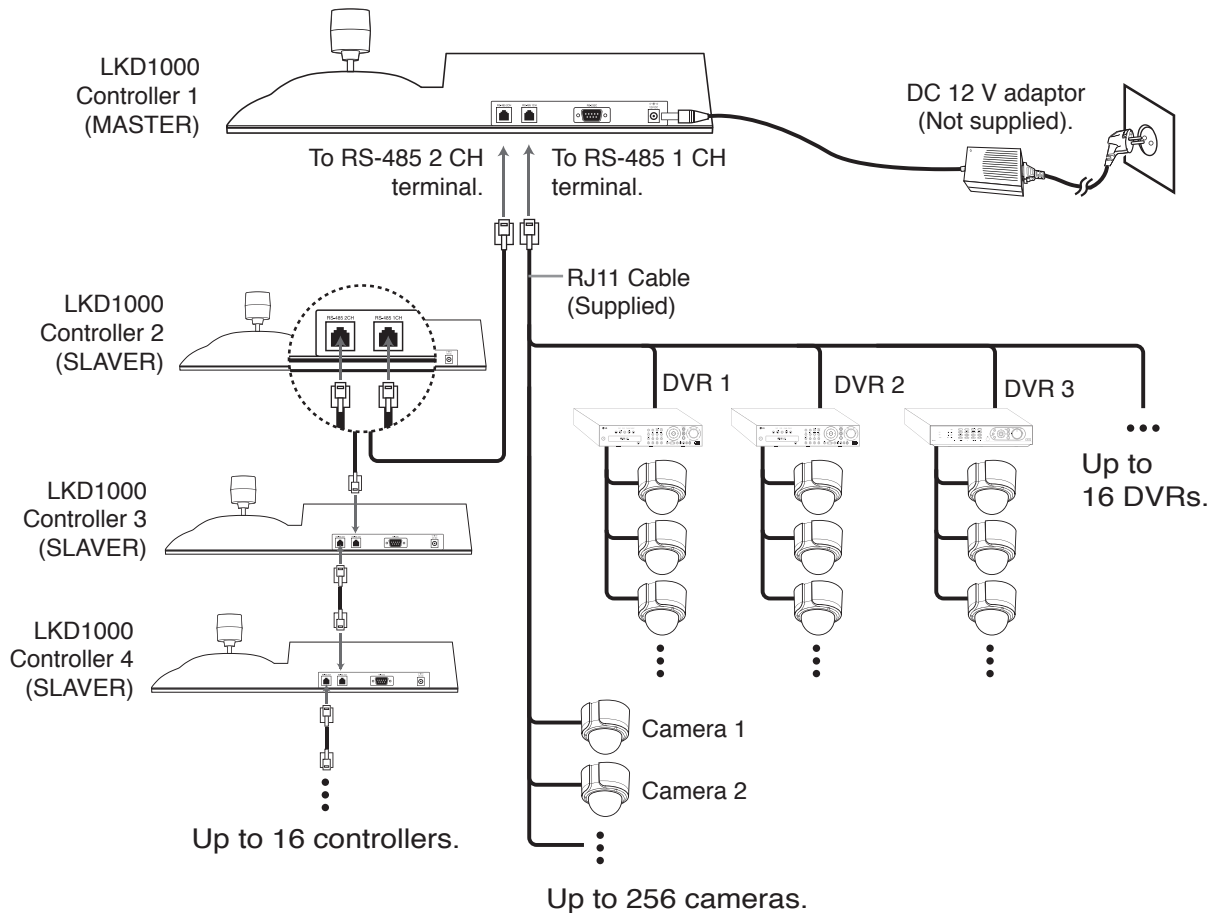

Notes:

- Please refer to the LG DVR and Camera manuals as necessary for additional connection information.
- Set the DVR ID and Camera ID differently for each DVR and Camera if many DVRs or cameras are connected to the LKD1000 controller.

RS-485 Connection

Use this port to connect PTZ cameras or LG DVRs. Use the cable that is described below for RS-485 site communication.

- Shielded, twisted pair cable
- Low impedance
- Wire gauge size is thicker than AWG #22 (0.33 mm²).

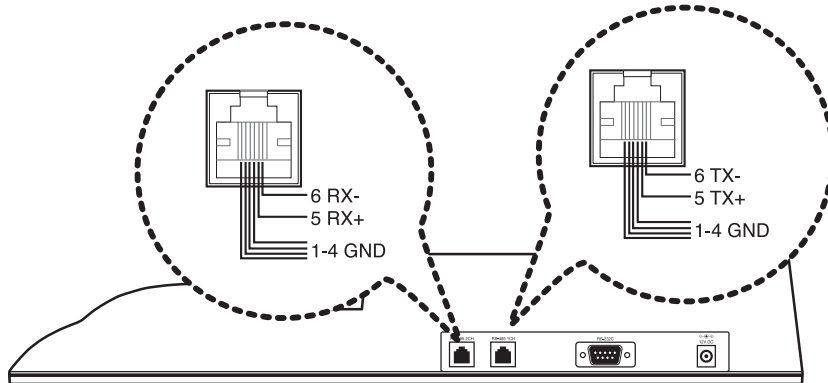

Connecting the LG DVR

You can connect up to 16 LG DVRs.

Connect the LG DVR to the RS-485 1 CH terminal of the LKD1000 as shown below.

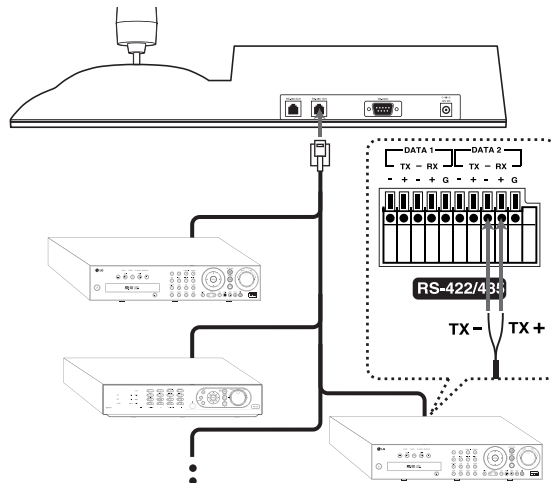

Notes:

- When connecting lines, connect the TX - of the LKD1000 controller to RX - (DATA2) of the LG DVR and TX + of the LKD1000 controller to RX + (DATA2) of the LG DVR correctly.
- Set the appropriate DVR system ID to operate via the LKD1000 Controller when using the multiple LG DVR.

Connecting the PTZ Camera

You can connect up to 256 PTZ cameras. Connect the PTZ Camera to the RS-485 1 CH terminal of the LKD1000 as shown below.

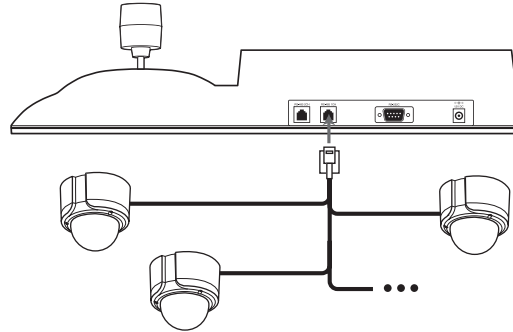

Connecting the multiple LKD1000 controller

You can connect up to 16 LKD1000 controllers. If you use the multiple LKD1000 controller, you must set the LKD1000 ID. Set to 1 for master controller and set to the other ID number (2 to 16) for the slave controller. The Slave LKD1000 controller can control the DVRs or cameras through the master LKD1000 controller. When connecting multiple LKD1000 controllers, connect as shown below.

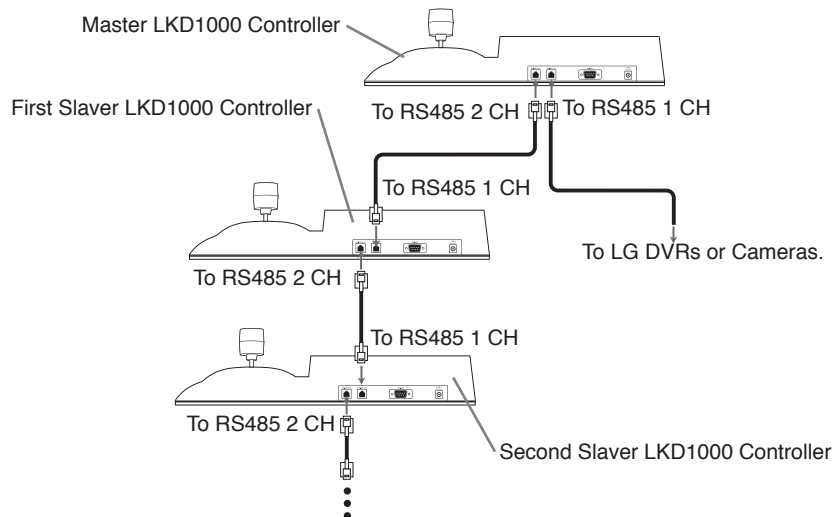

Note:

When you turning off the slave LKD1000 controller, you should disconnect the RS485 cable between the master LKD1000 controller and slaver LKD1000 controller to prevent a malfunction of the master LKD1000 controller.

System Operation

Before starting operation, user authentication by the password is required.

1. Check that the LG DVR or the camera, the monitor and peripherals are connected correctly and securely.
2. Connect an DC 12 V power source to the DC 12 V input terminal on the back of the controller.
3. Select a user by using the arrow (←/→) buttons, then press the ENTER button.
 - Administrator: Unlimited operation of the unit. Only administrator can access the LKD1000 setup menu and camera control menu.
 - Operator: Limited operation of the unit. (Emulate the DVR keys and PTZ function are available.)

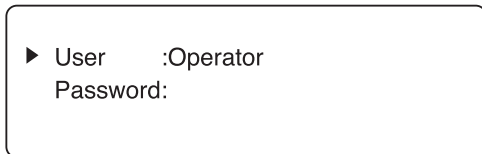

4. Enter your password using the number buttons then press ENTER. (Initial password is "000000".) The main menu will appear in the display window.

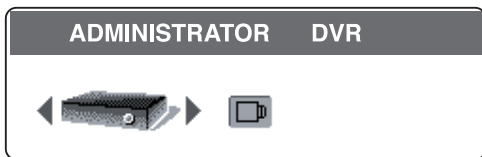

LKD1000 SETUP MENU

The setup menu has several submenus. All of these main menus are further divided into submenus.

Press **Setup** to display the setup menu.

Key Functions on the Setup menu

- **Setup button:** To display the main menu.
- **ENTER button:** To execute or select modes and parameters. To enter a submenu for the selected item.
- **CLR button:** To return to the previous menu or to delete input.
- **Numeric buttons:** Enter numbered value in a menu.
- **Arrow buttons:** Choose an item in the menu.

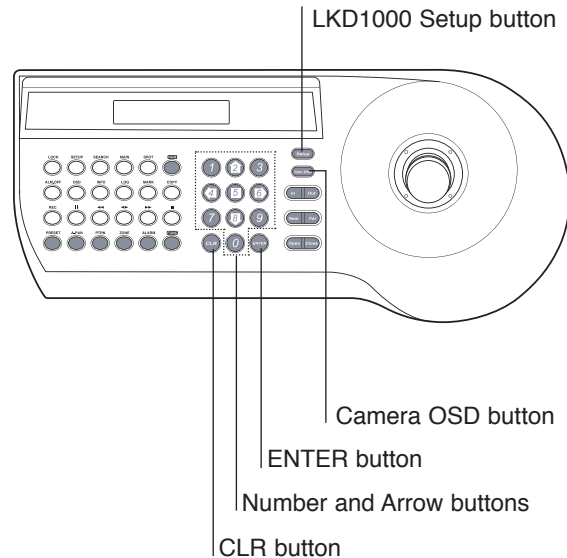

Change Password

The factory default of password is "000000". However, for security, you should change the password setting.

1. Select [Change Password] option then press ENTER. The sub menu will appear.

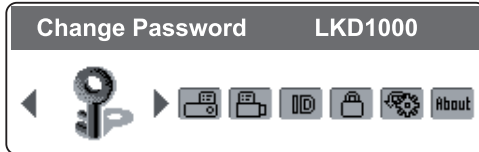

2. Select the user to change the password and press ENTER.

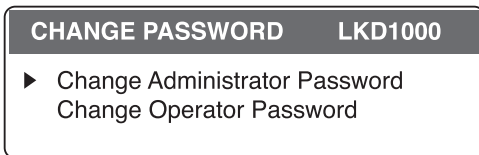

3. Enter current password using the number buttons then press ENTER. If you select [Change Operator Password] option, enter the administrator's password.

- In case of Administrator:

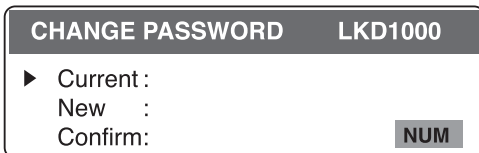
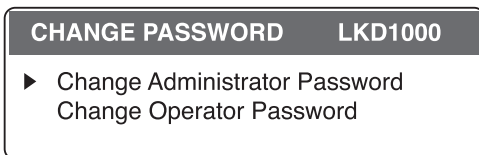

- In case of Operator:

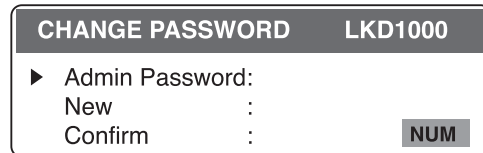
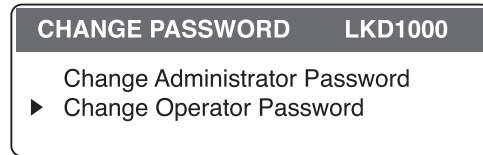

4. Enter new password using the number buttons then press ENTER. Enter the password again to confirm, and press ENTER. The password is stored.

Notes:

- You can enter the password from minimum 1-digit number to 10-digit numbers.
- We recommend that you do not operate the controller during saving the password.

About DVR

Select [ABOUT DVR] option then press ENTER. Shows DVR information.

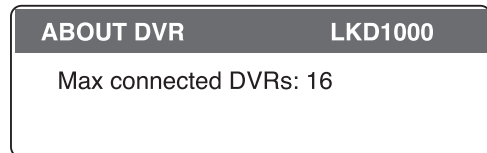
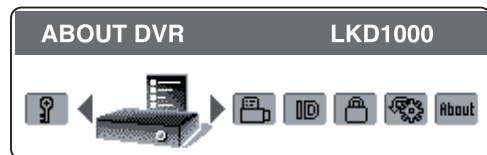

About Camera

Select [ABOUT CAMERA] option then press ENTER.
Shows camera information.

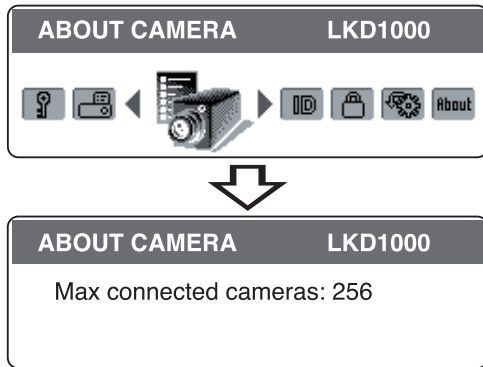

Change ID Setting

This LKD1000 controller has the controller ID. If you use 2 controllers or more simultaneously, set the controller ID for each controller.

1. Select [CHANGE ID] option then press ENTER.
The sub menu will appear.

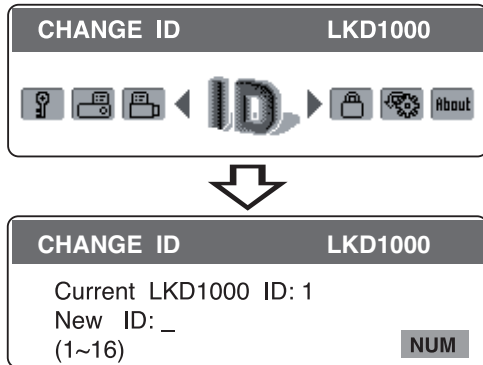

2. Enter the New LKD1000 ID for this controller (1 to 16).
3. Press ENTER to save the settings.

Auto Lock Setting

The keys on the controller is locked when there is no operation for selected duration on the [AUTO LOCK] option. To release the Key Lock mode, you need to enter the password.

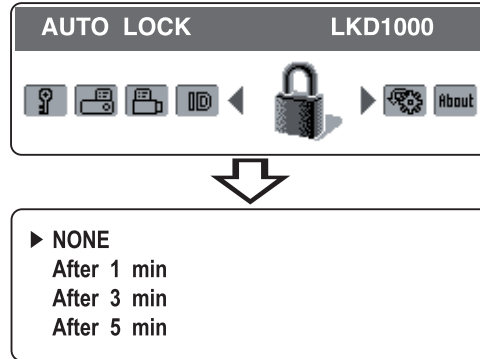

- NONE: Auto Key Lock function is disable.
- After 1 min: The keys on the controller are locked when there is no operation for 1 minute.
- After 3 min: The keys on the controller are locked when there is no operation for 3 minutes.
- After 5 min: The keys on the controller are locked when there is no operation for 5 minutes.

Factory Reset

If you need to, you can reset the LKD1000 controller to its original factory settings.

1. Select [FACTORY RESET] option then press ENTER.
The sub menu will appear.



2. Enter the password and press ENTER.

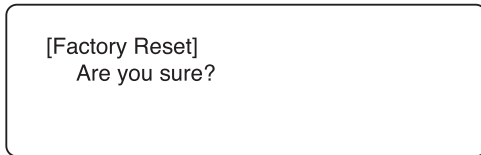

3. Press ENTER to confirm it.

About LKD1000

Select [ABOUT LKD1000] option then press ENTER. Shows model name and the current firmware version of the controller.

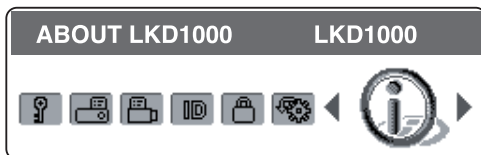

OPERATION

Operation the LG DVR

You can control the connected LG DVR using the LKD1000 controller.

1. Select DVR icon in the main menu and then press ENTER. The DVR ID input menu will be displayed.

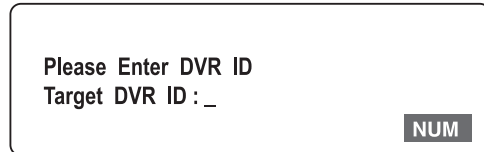
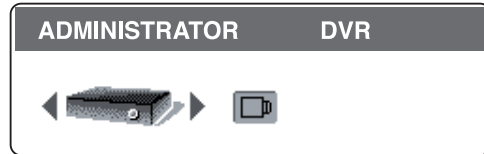

2. Enter the connected DVR ID to control the DVR and then press ENTER. The DVR key emulation menu will be displayed.

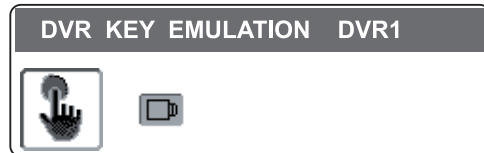

3. Press ENTER to change the DVR control mode.

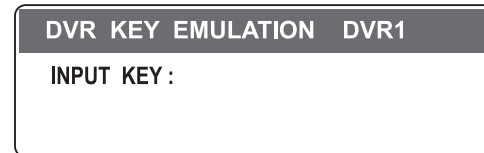

4. Use the DVR function keys to control the DVR.

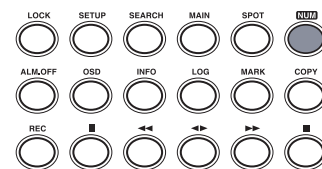

- **LOCK**
Displays the lock menu to change the user type or disable the system operation.
- **SETUP**
Displays the setup menu or cancels operation on the setup menus. Use to return to the previous menu or mode.
- **SEARCH**
Displays the search menu.
- **MAIN**
Display the MAIN menu to set the screen mode to full, 4, 6, 8, 9 or 16 screens.
- **SPOT**
Enter SPOT mode to allow spot monitor control.
- **NUM**
Switches to number entering mode in a menu.
- **ALM.OFF**
Cancels alarm activation and returns the system to the condition before the alarm was activated.
- **OSD**
Accesses or removes the System Control Bar.
- **INFO**
Displays or removes system information.
- **LOG**
Displays or removes the System Log List.
- **MARK**
Sets the mark point for recording search.
- **COPY**
Copies the recording data to an external device.
- **REC**
Starts or stops instant recording.

How to instant recording

- (1) Press the REC.
- (2) Press the NUM and then press the channel button you want to record.
- (3) Press ENTER to start recording. The recording type indicator turns green on the selected channel screen.
- (4) If you stop the recording, repeat the step (1) to (3) as the above.

- **Playback control buttons**

- **⏸**: Pauses playback.
- **⏮**: Search the recorded images in reverse or skip the recorded images.
- **⏪**: Playback or reverse playback of recorded images.
- **⏩**: Forward search the recorded images or skip the recorded images.
- **■**: Stops playback.

5. Press CLR to exit the DVR control mode.

Operation the connected camera via the DVR

You can control the connected camera via the LG DVR using the LKD1000 controller.

1. Follow steps 1 to 2 described in "Operation the LG DVR".
2. Use the Arrow (←/→) buttons to select the camera and then press ENTER. The DVR/CAM ID input menu will be displayed.

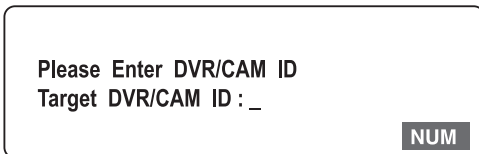

3. Enter the connected DVR/CAM ID to control the camera connected to the DVR and then press ENTER. The camera control menu will be displayed.

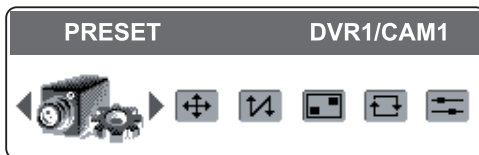

4. Use the Arrow (←/→) buttons to select the "COMMUNICATION" option and press ENTER.

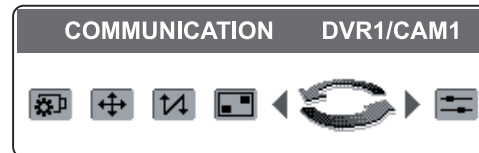

5. Set the desired options. (For more details, see pages 26 to 28)
6. Use the camera control buttons and joystick to control the camera.

Operation of the camera connected to the LKD1000 controller directly

You can control the camera connected to the LKD1000 controller directly.

1. Select CAM (Camera) icon in the main menu and then press ENTER. The camera ID input menu will be displayed.

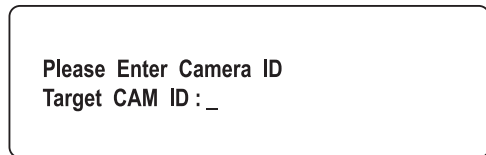

2. Enter the connected camera ID to control the camera connected to the LKD1000 controller directly and then press ENTER. The camera control menu will be displayed.



3. Use the Arrow (←/→) buttons to select the "COMMUNICATION" option and press ENTER.
4. Set the desired options. (For more details, see pages 26 to 28)
5. Use the camera control buttons and joystick to control the camera.

Camera Control Menu

The Camera Control menu has several submenus. All of these main menus are divided into submenus.

Camera Control menu overview

Main Menu	Sub Menu	Page
PRESET	Set Preset	17
	Go To Preset	18
	Tour	18
	Edit Group	19
	Group Tour	20
	Clear Preset	21
	Clear All Preset	21
	Set Alarm Input	22
	Set Alarm Output	22
AUTO PANNING	Set Auto Panning	23
	Run Auto Panning	24
PATTERN	Record Pattern	24
	Play Pattern	25
PRIVACY ZONE	Set Zone Area	25
	Display Zone Area	26
COMMUNICATION	Protocol	26
	Baudrate	27
	Parity Bit	27
	Data Bit	28
	Stop Bit	28
	Sync Communication	28
CAMERA SETUP	Set Manual Focus Speed	29
	Go To PTZ Home Position	29
	Periodic PTZ Reset	30
	PTZ Reset	30
	Factory Reset	31

Notes:

- The pictures used in the camera control menu are based on DVR-camera menu.
- Depending on protocol, some functions are not activated. See page 33 for more details.

Preset Settings

Preset is the function to register camera monitoring positions (pan, tilt and zoom positions) associated with position numbers.

By entering the position numbers, you can set cameras to the preset positions.

Note:

To activate this function, you need to register the preset positions of camera.

To register preset positions

- Select the [PRESET] icon and press ENTER. The sub menu will appear.

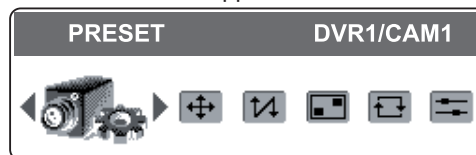

- Select [Set Preset] option then press ENTER. The sub menu will appear.

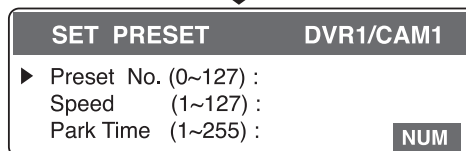

- By moving the joystick, move the camera to a point you want.
- Enter a [Preset No.] (0 to 127) you want to register by pressing the numeric buttons then press ENTER.
- Enter a [Speed] (1 to 127) to move to the preset position. Then press ENTER.
- Enter a [Park Time] (holding time) (1 to 255). Then press ENTER. The position and its number are memorized for later recall.
- Repeat steps 3 to 6 to add additional position.
- Press CLR to return to the previous menu.

Changing to Picture at Preset Position

The following function is available only with cameras provided with the preset function. The preset function makes the camera move to the programmed preset position. It is necessary to program preset positions for the camera beforehand.

1. Select the [PRESET] icon and press ENTER. The sub menu will appear.

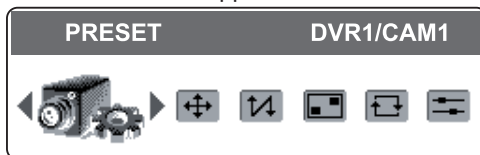

2. Select [Go to Preset] option then press ENTER. The sub menu will appear.



3. Use number buttons to enter the memorized preset position's index number then press ENTER. The camera moves to the preset position and the picture of the camera in that position appears on the monitor.

To tour the preset positions

You can tour all preset positions.

1. Select the [PRESET] icon and press ENTER. The sub menu will appear.

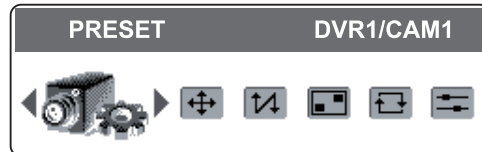

2. Select [Tour] option then press ENTER. The sub menu will appear.

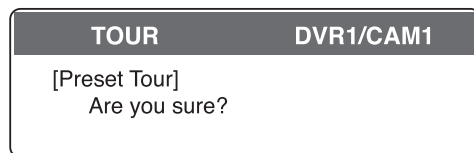
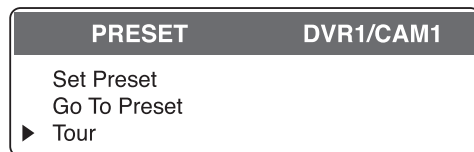

3. Press ENTER. All registered preset positions in the camera will be selected, and the camera position image will be displayed on the active monitor.
4. Move the joystick to stop the tour.

Note:

After executing Preset Touring, Group Touring, Run Auto Panning or Play Pattern operation, the ongoing operation has to be stopped by moving the joystick before executing any other operation. Failure to do this can make the target camera not working as intended.

To edit the group

You can create a group using preset positions that are registered already. A maximum of 9 groups is available.

1. Select the [PRESET] icon and press ENTER. The sub menu will appear.

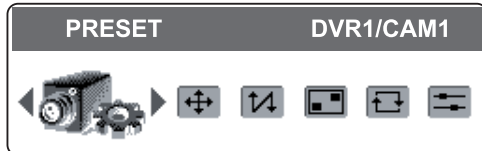

2. Select [Edit Group] option then press ENTER. The sub menu will appear.

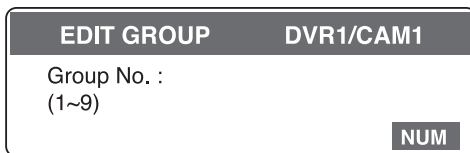
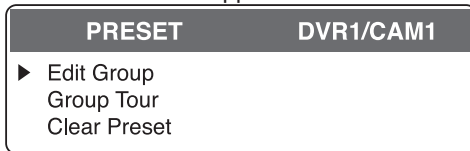

3. Enter the group number (1 to 9) then press ENTER.
4. Select [Add Preset] or [Delete Preset] then press ENTER.

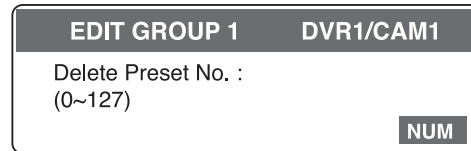
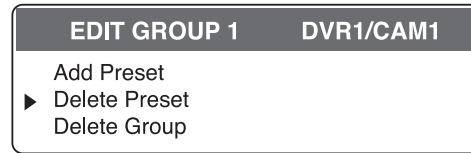
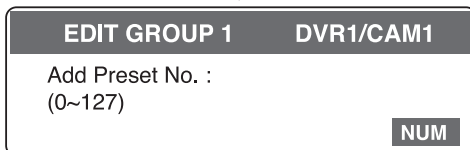
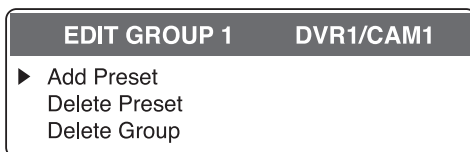

5. Enter the preset number that is already registered and press ENTER. The preset number is added to the group or deleted from the group.
 6. Repeat step 5 to add or delete preset number.
- Note:**
The group related parameters differ depending on cameras. So please refer to camera's manual.
7. Press CLR to exit edit group mode.

To delete a group

You can delete a memorized group.

1. Follow steps 1 to 2 described in "To edit the group".
2. Enter the group number (1 to 9) then press ENTER.
3. Select [Delete Group] then press ENTER. The delete group menu is displayed.

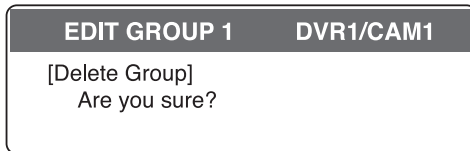
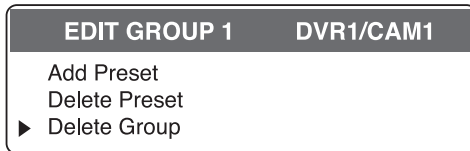

4. Press ENTER. The group will be deleted.

To tour the group

You can tour the group that is registered already.

1. Select the [PRESET] icon and press ENTER. The sub menu will appear.

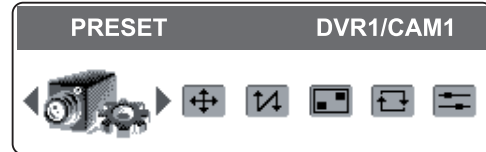

2. Select [Group Tour] option then press ENTER. The sub menu will appear.

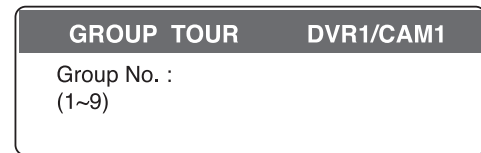
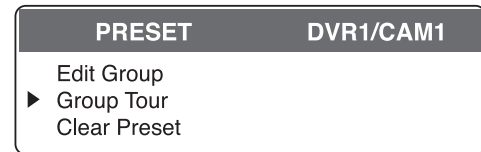

3. Use number buttons to enter the group number that is already registered then press ENTER. The camera moves to the preset position in the group and the picture of the camera in that position appears on the monitor.

To clear the preset position

You can delete a memorized preset position.

1. Select the [PRESET] icon and press ENTER.
The sub menu will appear.

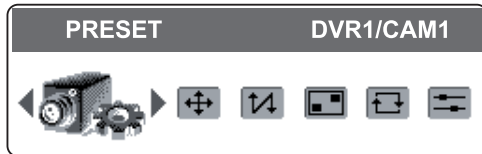

2. Select [Clear Preset] option then press ENTER.
The sub menu will appear.



3. Use number buttons to enter the memorized preset index number then press ENTER.
The preset position will be deleted.

To clear all preset position

You can delete all memorized preset position.

1. Select the [PRESET] icon and press ENTER.
The sub menu will appear.

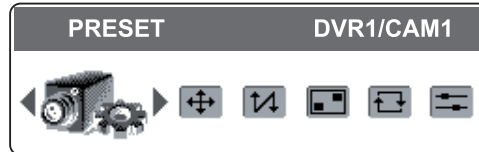

2. Select [Clear All Preset] option then press ENTER.
The sub menu will appear.

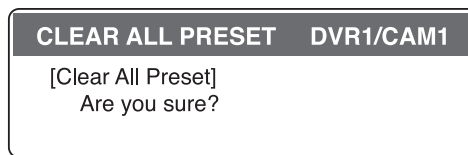
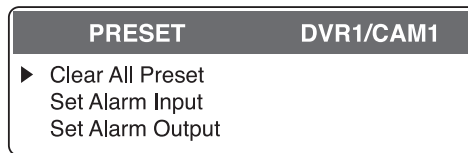

3. Press ENTER to delete all preset positions.

Note:

Depending on protocol, it can take a while to clear all preset positions.

To set Alarm Input

You can set alarm input mode, alarm index, and duration time. Preset numbers 1 to 8 are linked to alarm inputs 1 to 8 respectively. If alarm input 1 comes in, the camera turns to preset position 1, and to other positions according to alarm input 2 to 8. (This operating description is based on the LG product.)

1. Select the [PRESET] icon and press ENTER. The sub menu will appear.

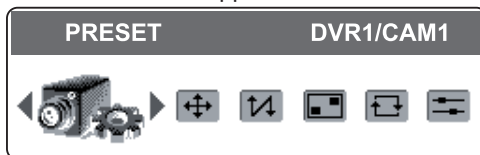

2. Select [Set Alarm Input] option then press ENTER.

The sub menu will appear.

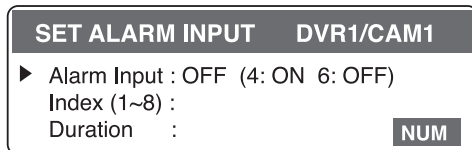
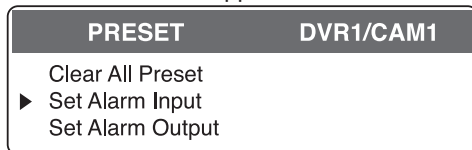

3. Use 4 (ON) or 6 (OFF) number buttons to select Alarm Input Mode then press ENTER.
 - ON: Alarm input signals are supplied from external devices through the ALARM IN connector on the camera to turn the camera to a preset position.
 - OFF: The camera ignores alarm inputs.
4. Enter a [Alarm Index] number (1 to 8) then press ENTER.

Note:

The available alarm index differs depending on cameras. So please refer to camera's manual.

5. Enter a [Duration] (0 to 255) then press ENTER. Displays the picture at the preset position for the selected duration. (0 (Manual mode); the camera hold at the preset position continuously. To escape Manual mode, set the [Alarm Input] to OFF.) Alarm input setting is finished and the setting is memorized in the camera's memory.
6. Repeat the steps 3 to 5 to set additional Alarm Input.

To set Alarm Output

You can set alarm output mode, alarm index, and duration time. When alarm inputs are supplied via the alarm input connector on the camera, the camera sends output signals via the alarm output connector on the camera.

Alarm output numbers 1 to 4 are linked to alarm inputs 1 to 4 respectively. If alarm input 1 comes in, the camera sends output signals via the alarm output 1 connector on the camera. (This operating description is based on the LG product.)

Note:

You cannot use this function with a camera without alarm output connector.

1. Select the [PRESET] icon and press ENTER. The sub menu will appear.

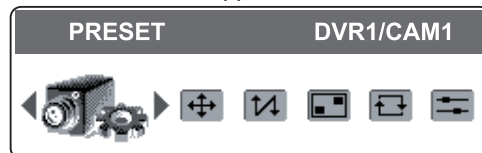

2. Select [Set Alarm Output] option then press ENTER. The sub menu will appear.

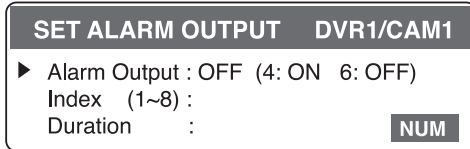
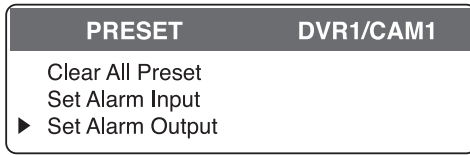

3. Use 4 (ON) or 6 (OFF) number buttons to select Alarm Output Mode then press ENTER.
 - ON: If alarm input comes in, the camera sends output signals.
 - OFF: The camera does not send an output signal.
4. Enter a [Alarm Index] number (1 to 4) then press ENTER.
5. Enter a [Duration] (0 to 255) then press ENTER. Sends the output signals for the selected duration. (0 (Manual mode); the camera sends output signals continuously.)
Alarm output setting is finished and the setting is memorized to the camera's memory.
6. Repeat steps 3 to 5 to set additional Alarm Output.

Auto Pan Setup and Activation

You will set up and activate the auto pan function. The camera can pan among the points you will set.

Note:

Refer to the operating instructions of camera for details on the auto pan function.

To set the points of auto pan

1. Select the [AUTO PANNING] icon and press ENTER. The sub menu will appear.



2. Select [Set Auto Panning] option then press ENTER. The sub menu will appear.

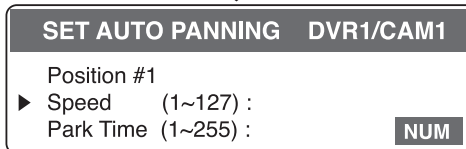
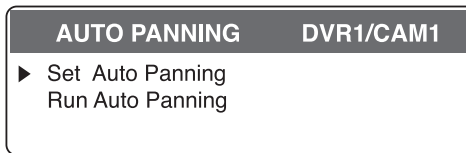

3. By moving the joystick, move the camera to a point you want.
4. Enter a [Speed] (1 to 127) to move to the preset position. Then press ENTER.
5. Enter a [Park Time] (holding time) at the preset position (1 to 255). Then press ENTER.
The setting is finished and the setting is memorized in the camera's memory.
6. Repeat the steps 3 to 5 to add additional position.

Note:

When the maximum position is reached, it goes automatically to upper level menu. Use the CLR button to quit this menu before the maximum position is reached. Please refer to the camera's manual for the number of available auto panning position.

To activate auto pan

1. Select the [AUTO PANNING] icon and press ENTER. The sub menu will appear.



2. Select [Run Auto Panning] option then press ENTER. The sub menu will appear.

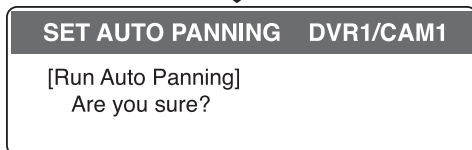
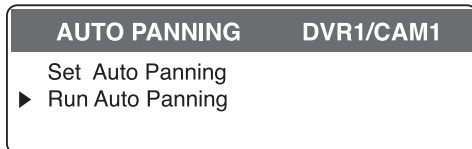

3. Press ENTER to activate auto pan.
4. Move the joystick to stop the auto panning.

Pattern Setup and Activation

You will perform the pattern setup and the pattern play.

Note:

The available patterns differ depending on camera. So please refer to camera's manual.

To record the pattern

1. Select the [PATTERN] icon and press ENTER. The sub menu will appear.



2. Select [Record Pattern] option then press ENTER. The sub menu will appear.

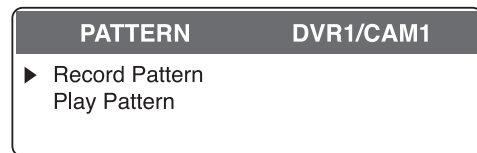

3. Use number buttons to select the pattern index number then press ENTER to confirm. Pattern recording starts.

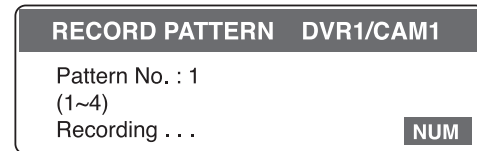

4. Perform desired camera operations by moving the joystick or pressing In/Out buttons. The following controls are available for recording the pattern.
 - Panning/Tilting/Zoom control (joystick)
 - Zoom control (In/Out buttons)

- If you finish to record, press ENTER or CLR.
The pattern is memorized in the camera's memory.
- Repeat the steps 2 to 5 to add additional position.

Note:

The available total time of pattern differs depending on camera's operation.

Pattern Play

You can activate the pattern play function for the selected camera.

- Select the [PATTERN] icon and press ENTER.
The sub menu will appear.



- Select [Play Pattern] option then press ENTER.
The sub menu will appear.

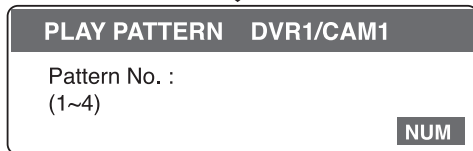
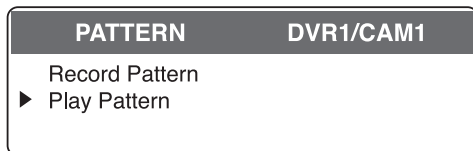

- Use number buttons to enter the memorized pattern index number then press ENTER.
The camera plays the pattern.
- Move the joystick to stop playing.

Privacy Setup

This setting is used for masking unwanted zones, hiding them from display on the monitor screen. Up to 8 zones can be registered. Submenus are provided for zone number selection and parameter setting.

To register a new privacy zone

- Select the [PRIVACY ZONE] icon and press ENTER.
The sub menu will appear.



- Select [Set Zone Area] option then press ENTER.
The sub menu will appear.

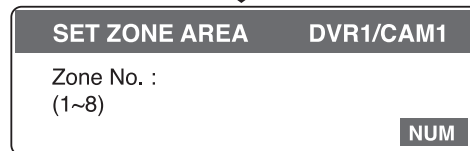
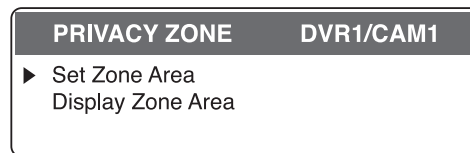

- Use number buttons to select the zone index number then press ENTER to confirm.
The zone frame appears on the center of monitor.
- Adjust the pan, tilt, and zoom position so that the desired position comes into the zone frame with the joystick.
- Press ENTER. The privacy zone setting has been completed.
- Repeat the steps 2 to 5 to add additional position.

To display or disappear privacy zone

1. Select the [PRIVACY ZONE] icon and press ENTER.
The sub menu will appear.



2. Select [Display Zone Area] option then press ENTER.
The sub menu will appear.

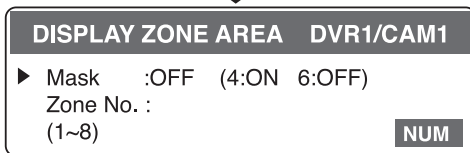
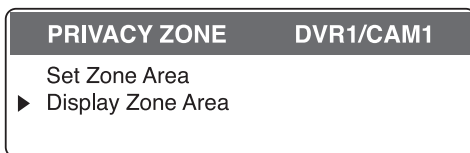

3. Use 4 (ON) or 6 (OFF) number buttons to select Mask Mode then press ENTER.
 - ON: Preset privacy zones are veiled on the monitor screen.
 - OFF: The veiling function is disabled.
4. Enter a [Zone No] number (1 to 8).
The display zone setting has been completed and the setting is memorized in the camera's memory.
5. Repeat steps 3 to 4 to set additional zone.

Communication Settings

This setting is required to establish a connection between the system units and system controller.

Protocol Setting

This item lets you set a protocol for RS-485 communication.

1. Select the [COMMUNICATION] icon and press ENTER.

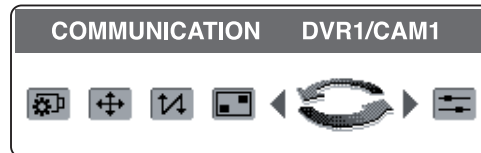

2. Select [Protocol] option then press ENTER.
The sub menu will appear.

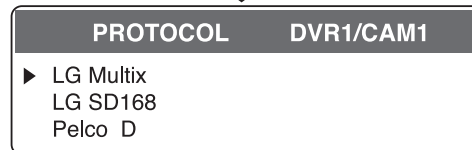
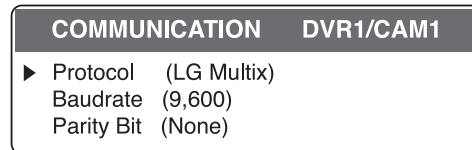

3. Select the desired parameter from [LG Multix], [LG SD168], [Pelco D], [Pelco P], [LG Zoom], [LPT A100L], [LG Multix Extension] and [LS900].
4. Press ENTER to save the settings.

Baud Rate (Communication Speed) Setting

The speed of communication between the system controller and the camera.

1. Select the [COMMUNICATION] icon and press ENTER.

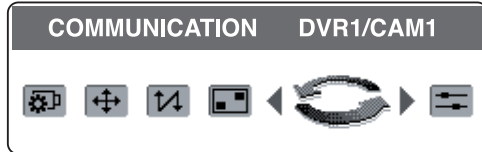

2. Select [Baudrate] option then press ENTER. The sub menu will appear.

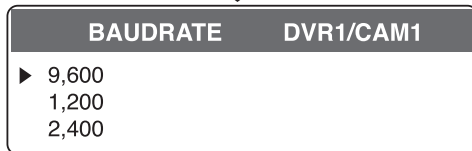
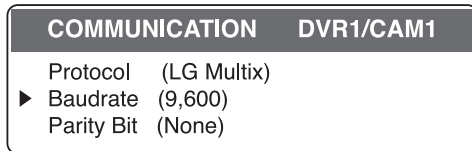

3. Select the desired parameter from 9 600 / 1 200 / 2 400 / 4 800 / 19 200 / 38 400 / 57 600 / 115 200 bps.

Note:

Conform this parameter to the baud rate of other system units. Otherwise, communication will not be established between the system controller and system units.

4. Press ENTER to save the settings.

Parity bit Setting

The parity bit, added to the data, to perform parity check.

1. Select the [COMMUNICATION] icon and press ENTER.

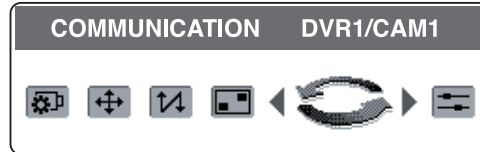

2. Select [Parity Bit] option then press ENTER. The sub menu will appear.

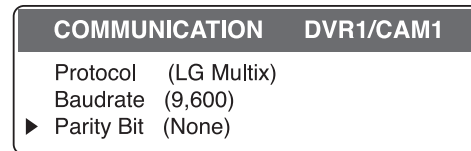

3. Select the desired parameter from [None], [Even Parity], and [Odd Parity].
4. Press ENTER to save the settings.

Data Bits Setting

This item lets you set the number of the data bits for RS-485 communication.

1. Select the [COMMUNICATION] icon and press ENTER.

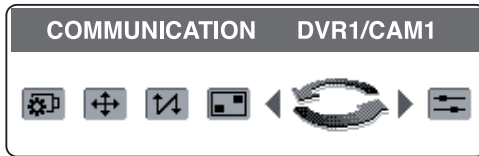

2. Select [Data Bit] option then press ENTER. The sub menu will appear.

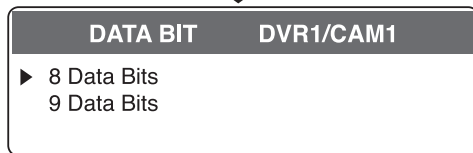
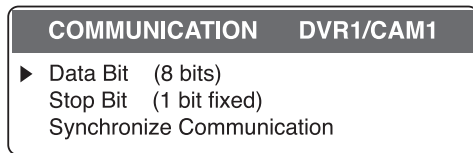

3. Select the desired parameter from [8 Data Bits] and [9 Data Bits].

Note:

This setting must be compatible with the peripherals connected.

4. Press ENTER to save the settings.

Stop Bit Setting

The stop bit, added to the last of data, in asynchronous communication.

The parameter is fixed to [1bit].

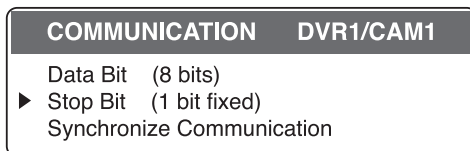

Synchronize Communication Setting

Synchronize menu is for re-constructing H/W communication settings between LG DVR and Camera connected to LG DVR. When the H/W communication setting (baudrate, parity, and data bit) between LG DVR and Camera connected to LG DVR is not match, you will not be able to control the camera.

The unmatched communication setting can be happened because more than one LKD1000 can control one DVR at the same time or because the setting is changed by internal DVR application. Therefore if you can not control the camera connected to LG DVR even though the communication setting is correct, please consider this option (pushing synchronize menu). Exiting to upper level menu then re-entering the DVR/CAM ID will have the same effect as this function.

1. Select the [COMMUNICATION] icon and press ENTER.

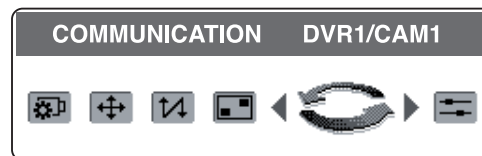

2. Select [Synchronize Communication] option then press ENTER.

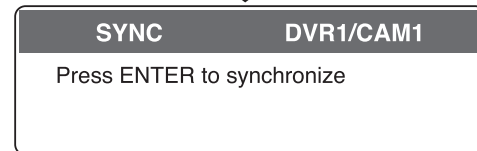
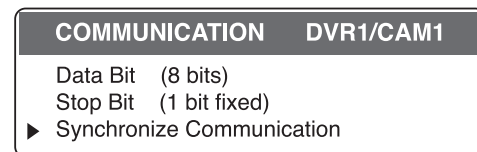

3. Press ENTER to synchronize.

Camera setup

In this menu, you can customize the settings provided.

Set Manual Focus Speed

1. Select the [CAMERA SETUP] icon and press ENTER.

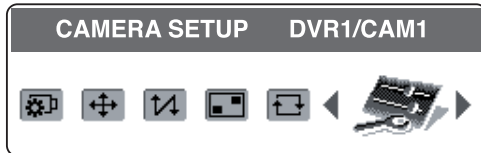

2. Select [Set Manual Focus Speed] option then press ENTER.

The sub menu will appear.

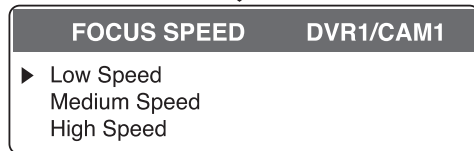
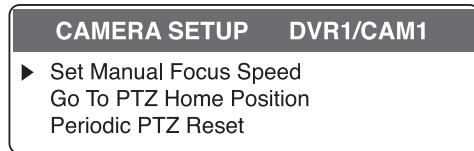

3. Select a focus speed from among "Low Speed", "Medium Speed", or "High Speed".

Go To PTZ Home Position

The home position is the camera's basic position. The camera returns to this position after executing the [Go To PTZ Home Position] option.

1. Select the [CAMERA SETUP] icon and press ENTER.

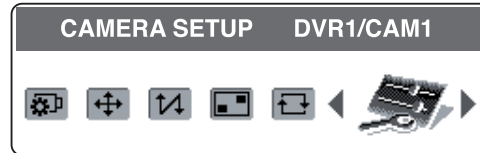

2. Select [Go To PTZ Home Position] option then press ENTER.

The sub menu will appear.

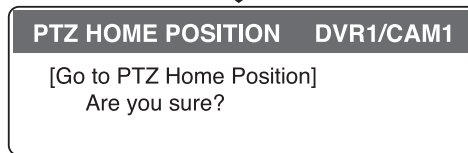
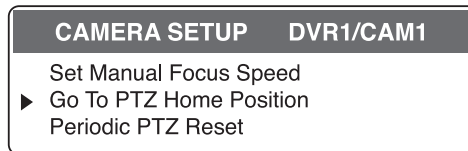

3. Press ENTER to confirm it.

Periodic PTZ Reset

You can set the camera to periodically reset its PTZ position.

1. Select the [CAMERA SETUP] icon and press ENTER.

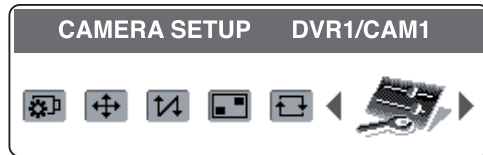

2. Select [Periodic PTZ Reset] option then press ENTER.

The sub menu will appear.

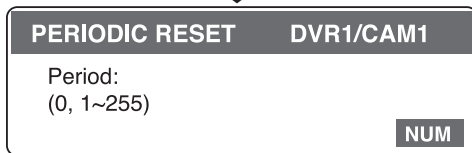
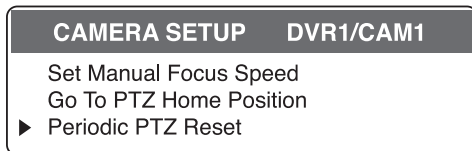

3. Use number buttons to select the period then press ENTER to confirm the selection.
 - 0 : Disable the PTZ position reset.
 - 1 to 255 : Reset the PTZ position once per number of days you set.

PTZ Reset

You can reset the camera's PTZ position without change of camera's internal data.

1. Select the [CAMERA SETUP] icon and press ENTER.

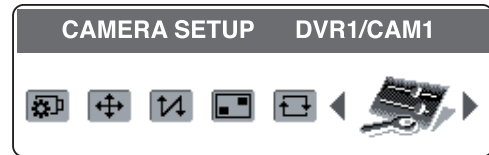

2. Select [PTZ Reset] option then press ENTER. The sub menu will appear.

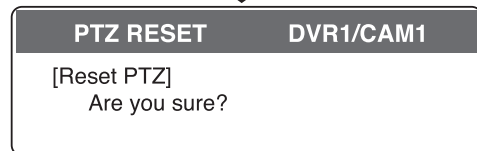
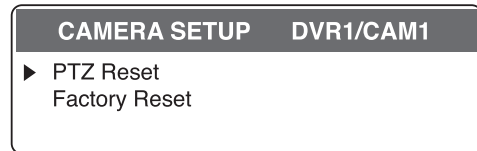

3. Press ENTER to confirm it.

Factory Reset

You can reset all camera's settings to factory default.

1. Select the [CAMERA SETUP] icon and press ENTER.

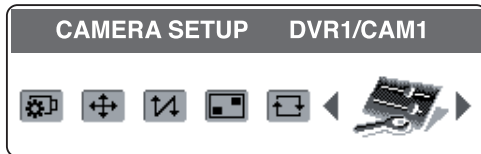

2. Select [Factory Reset] option then press ENTER. The sub menu will appear.

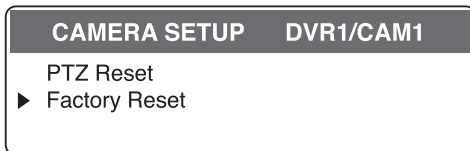

3. Enter the password and press ENTER.

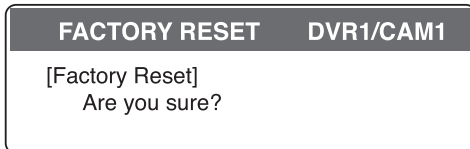

4. Press ENTER to confirm it.

REFERENCE

Camera Control Function

Camera control functions are operable. It is necessary to set up the camera before using the camera control functions. For further information, refer to the Operating Instructions for the respective combination camera. You can also set it up from the Camera Setup menu during operating the system.

Pan/Tilt Control

A combination camera or an ordinary camera with pan/tilt head can be controlled. Move the pan/tilt head in the desired direction using the joystick.

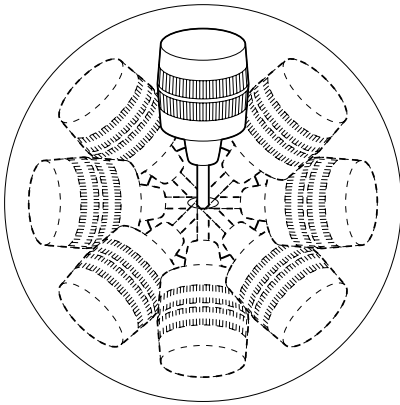

The speed of the moving camera is adjusted according to the slope of joystick handle when you operate the Pan/Tilt. You can adjust the zoom speed by rotating it rightwards or leftwards.

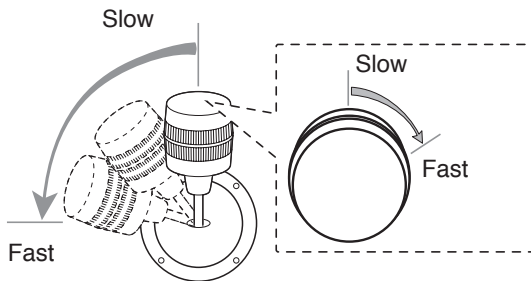

Lens Control

The following functions are available with cameras provided with controllable lens.

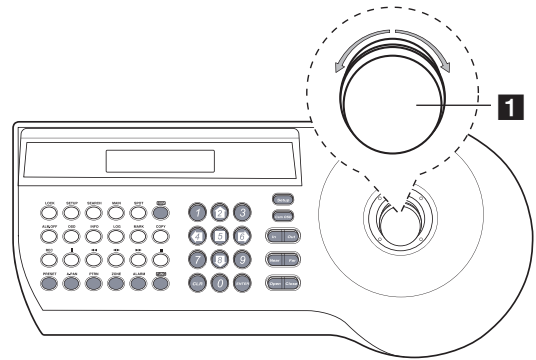
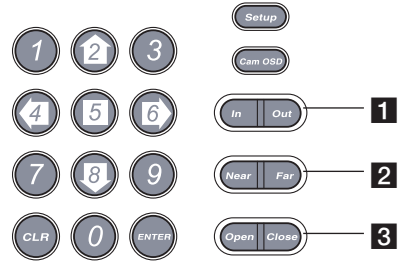

- 1 Press the [In/Out] button or turn the joystick head right/left to zoom in/out.

Note:

Zooming capability depends to the camera.

- 2 Press the Near or Far button to adjust the lens focus while watching the monitor.
- 3 Press the Open or Close button to adjust the lens iris while watching the monitor.

Protocol Function Table

FUNCTION		REQUIRED PARAMETER	PROTOCOL							
			LG MULTIX	LG SD168	PELCO P	PELCO D	LG ZOOM	LPT A100L	LG MULTIX E	LS900
	OSD		O	O	O	O	O	O	O	O
Preset	Set Preset		O	O	O	O	X	X	X	X
		Preset index	O	O	O	O	X	X	X	X
		Speed	O	X	X	X	X	X	X	X
		Park time	O	O	X	X	X	X	X	X
	Go To Preset		O	O	O	O	X	X	X	X
		Preset index	O	O	O	O	X	X	X	X
	Tour		O	O	O	O	X	X	X	X
	Edit Group		O	X	X	X	X	X	X	X
		Group index	O	X	X	X	X	X	X	X
		Preset index	O	X	X	X	X	X	X	X
	Group Tour		O	X	X	X	X	X	X	X
		Group index	O	X	X	X	X	X	X	X
	Clear Preset		O	O	O	O	X	X	X	X
		Preset index	O	O	O	O	X	X	X	X
	Clear All Preset		O	O	O	O	X	X	X	X
	Set Alarm Input		O	X	X	X	X	X	X	X
Set Alarm Output		O	X	X	X	X	X	X	X	
	Mode	O	X	X	X	X	X	X	X	
	Alarm index	O	X	X	X	X	X	X	X	
	Duration time	O	X	X	X	X	X	X	X	
Auto Panning	Set Auto Panning		O	O	X	X	X	X	X	
		Position index	O	O	X	X	X	X	X	
		Speed	O	O	X	X	X	X	X	
		Park time	O	O	X	X	X	X	X	
	Run Auto Panning		O	O	X	X	X	X	X	
Pattern	Record Pattern		O	X	O	O	X	X	X	
		Pattern index	O	X	X	X	X	X	X	
	Play Pattern		O	X	O	O	X	X	X	
	Pattern index	O	X	X	X	X	X	X		
Privacy Zone	Set Zone Area		O	X	X	X	X	X	X	
		Mode	O	X	X	X	X	X	X	
		Mask Index	O	X	X	X	X	X	X	
	Display Zone Area		O	X	X	X	X	X	X	
		Mode	O	X	X	X	X	X	X	
	Mask Index	O	X	X	X	X	X	X		
Camera Setting	Set Manual Focus Speed		O	X	X	X	X	X	X	
		Focus speed	O	X	X	X	X	X	X	
	Go To PTZ Home Position		O	X	O	O	X	X	X	
	Periodic PTZ Reset		O	X	X	X	X	X	X	
		Period	O	X	X	X	X	X	X	
	PTZ Reset		O	X	O	O	X	X	X	
	Factory Reset		O	O	X	O	X	X	X	

Specifications

Communication	Signal	RS-485
	Connector	RJ11
	Baud Rate	1 200 / 2 400 / 4 800 / 9 600 / 19 200 / 38 400 / 57 600 / 112 500 bps
Joy-Stick Type	3-Axis	
Control	256 Camera ID / 16 DVR ID / 8 Protocol Selection	
	Pan / Tilt / Zoom / Iris / Focus	
	Preset Touring	
	Auto Panning	
	Pattern Settings	
	Privacy Zone Masking	
	Alarm Control	
	LG DVR (LDV-S500 series, LE3100 series, LE2100 series) key emulation (All function operated by DVR front key is supported).	
Connection	CH1	Operating only TX mode
	CH2	Operating only RX mode (Using for controller cascade)
Firmware Update	RS-232C	
Total Key Number	44	
Password	1 to 10 Digits	
Display	4 Gray Graphic LCD (256 x 72 dots)	
Operation Temp. / Humidity	-10 °C to 50 °C / 0 % RH to 80 % RH	
Storage Temp. / Humidity	-20 °C to 60 °C / 0 % RH to 85 % RH	
Supplied Voltage	DC 12 V, 125 mA	
Power consumption	1.5 W	
Weight	1 kg	
Dimension(H x V x D)	419 x 110 x 190 mm	

