



OWNER'S MANUAL

Color Video Camera

Please read this manual carefully before operating your set and retain it for future reference.

MODEL

LCB5100-BN

LCB5100-BP

LCB5100 Series



MFL67260144



CAUTION: TO REDUCE THE RISK OF ELECTRIC SHOCK
DO NOT REMOVE COVER (OR BACK)
NO USER-SERVICEABLE PARTS INSIDE
REFER SERVICING TO QUALIFIED SERVICE PERSONNEL.



This lightning flash with arrowhead symbol within an equilateral triangle is intended to alert the user to the presence of uninsulated dangerous voltage within the product's enclosure that may be of sufficient magnitude to constitute a risk of electric shock to persons.



The exclamation point within an equilateral triangle is intended to alert the user to the presence of important operating and maintenance (servicing) instructions in the literature accompanying the product.

FCC WARNING: This equipment may generate or use radio frequency energy. Changes or modifications to this equipment may cause harmful interference unless the modifications are expressly approved in the instruction manual. The user could lose the authority to operate this equipment if an unauthorized change or modification is made.

REGULATORY INFORMATION: FCC Part 15

This equipment has been tested and found to comply with the limits for a Class A digital device, pursuant to Part 15 of the FCC Rules. These limits are designed to provide reasonable protection against harmful interference when the equipment is operated in a commercial environment. This equipment generates, uses, and can radiate radio frequency energy and, if not installed and used in accordance with the instruction manual, may cause harmful interference to radio communications. Operation of this equipment in a residential area is likely to cause harmful interference in which case the user will be required to correct the interference at his own expense.

- A suitable conduit entries, knock-outs or glands shall be provided in the cable entries of this product in the end user.

- **Caution:** Danger of explosion if battery is incorrectly replaced. Replaced only with the same or equivalent type recommended by the manufacturer. Dispose of used batteries according to the manufacturer's instructions.
- Holes in metal, through which insulated wires pass, shall have smooth well rounded surfaces or shall be provided with brushings.

This Class A digital apparatus complies with Canadian ICES-003.
Cet appareil numérique de la classe A est conforme à la norme NMB-003 du Canada.

Warning: Do not install this equipment in a confined space such as a bookcase or similar unit.

Warning: Wiring methods shall be in accordance with the National Electric Code, ANSI/NFPA 70.

Warning: This is a class A product. In a domestic environment this product may cause radio interference in which case the user may be required to take adequate measures.

Warning: To reduce a risk of fire or electric shock, do not expose this product to rain or moisture.

Warning: The product has been dropped or the case is broken, turn off the power and unplug the power cord. (This may cause fire, electric shock, or injury.)

Warning: If the product has no video out or sound, please stop using. Unplug the power cable immediately and contact the service center. (This may cause fire or electric shock.)

Caution: This installation should be made by a qualified service person and should conform to all local codes.

Caution: To avoid electrical shock, do not open the cabinet. Refer servicing to qualified personnel only.

Caution: The apparatus shall not be exposed to water (dripping or splashing) and no objects filled with liquids, such as vases, shall be placed on the apparatus.

Caution: Prevent the power cable from being severely bent or having pressure exerted on it by a heavy object.

To disconnect power from mains, pull out the mains cord plug. When installing the product, ensure that the plug is easily accessible.

Disposal of your old appliance



1. When this crossed-out wheeled bin symbol is attached to a product it means the product is covered by the European Directive 2002/96/EC.
2. All electrical and electronic products should be disposed of separately from the municipal waste stream via designated collection facilities appointed by the government or the local authorities.
3. The correct disposal of your old appliance will help prevent potential negative consequences for the environment and human health.
4. For more detailed information about disposal of your old appliance, please contact your city office, waste disposal service or the shop where you purchased the product.

EEE Compliance with Directive. (for Turkey only)



LG Electronics hereby declares that this/ these product(s) is/are in compliance with the essential requirements and other relevant provisions of Directive 2004/108/EC, 2006/95/EC, and 2009/125/EC.

European Standards Centre:

Krijgsman 1, 1186 DM Amstelveen The Netherlands

Important Safety Instructions

1. Read these instructions.
2. Keep these instructions.
3. Heed all warnings.
4. Follow all instructions.
5. Do not use this apparatus near water.
6. Clean only with dry cloth.
7. Do not block any ventilation openings. Install in accordance with the manufacturer's instructions.
8. Do not install near any heat sources such as radiators, heat registers, stoves, or other apparatus (including amplifiers) that produce heat.
9. Do not defeat the safety purpose of the polarized or grounding-type plug. A polarized plug has two blades with one wider than the other. A grounding type plug has two blades and a third grounding prong. The wide blade or the third prong are provided for your safety. If the provided plug does not fit into your outlet, consult an electrician for replacement of the obsolete outlet.
10. Protect the power cord from being walked on or pinched particularly at plugs, convenience receptacles, and the point where they exit from the apparatus.
11. Only use attachments/accessories specified by the manufacturer.
12. Use only with the cart, stand, tripod, bracket, or table specified by the manufacturer, or sold with the apparatus. When a cart is used, use caution when moving the cart/apparatus combination to avoid injury from tip-over.
13. Unplug this apparatus during lightning storms or when unused for long periods of time.
14. Refer all servicing to qualified service personnel. Servicing is required when the apparatus has been damaged in any way, such as power-supply cord or plug is damaged, liquid has been spilled or objects have fallen into the apparatus, the apparatus has been exposed to rain or moisture, does not operate normally, or has been dropped.



Cautions for Safe Operation

Power Supply

This camera must always be operated by DC 12 V or AC 24 V Certified/Listed, class 2 power supply only.

Handling of the unit

Be careful not to spill water or other liquids on the unit. Be cautious not to get combustible or metallic material inside the body. If used with foreign matter inside, the camera is liable to fail or to get cause of fire or electric shock.

- Remove dust or dirt on the surface of the lens with a blower.
- Use a dry soft cloth to clean the body. If it is very dirty, use a cloth dampened with a small quantity of neutral detergent then wipe dry.
- Avoid the use of volatile solvents such as thinners, alcohol, benzene and insecticides. They may damage the surface finish and/or impair the operation of the camera.

Operating and storage location

Avoid viewing a very bright object (such as light fittings) during an extended period. Avoid operating or storing the unit in the following locations.

- Extremely hot or cold places (operating temperature -10 °C to 50 °C, however, we recommend that the unit be used within a temperature range of 0 °C to 45 °C)
- Damp or dust place
- Places exposed to rain
- Places subject to strong vibration
- Close to generators of powerful electromagnetic radiation such as radio or TV transmitters.

Contents

Features	8	3D-DNR Setting.....	27
Part Names and Functions	9	Privacy Mask Setting	27
Connections	11	Special Menu Settings	29
Precautions	11	SYSTEM Setting	33
Connection Overview	11	Specification	34
Connecting Display device	12		
Connecting Power Source.....	12		
Mounting the Lens.....	13		
Flange-back Adjustment	15		
Mounting the camera	16		
Menu Operation	17		
OSD Menu control buttons.....	17		
OSD Menu Overview	18		
General Operation.....	20		
Exposure Settings.....	20		
White Balance settings	24		
Day & Night Setting	25		
Motion Detection Setting.....	26		

Features

This Color Video Camera is designed for installation in a video surveillance system.

This manual contains instructions on how to install and manage the Color Video Camera in your video surveillance system.

Should you require any technical assistance, please contact authorized service center.

- High resolution and high sensitivity with a 6 mm (1/3 Type) Exview HAD II CCD.
- Automatically switch between DC 12 V and AC 24 V.
- Smart motion detector.

Part Names and Functions

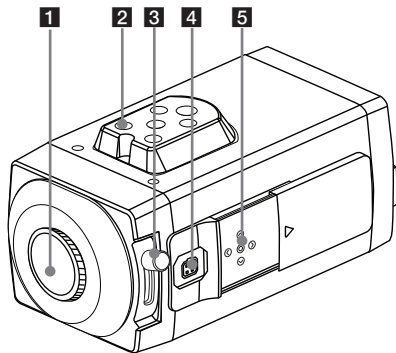

1 Lens mount cap

The lens mount of the camera is covered using a cap to protect it. Remove the lens cap covering the lens.

2 Camera installation bracket

The bracket can be fixed at the top or bottom of the camera.

3 Flange-back adjustment lever

4 Lens iris output connector (LENS)

This 4-pin connector is used to send the Iris control signal and power supply to an auto-iris type lens.

5 Setup menu control buttons

Use these buttons to set the menu options.

Part Names and Functions

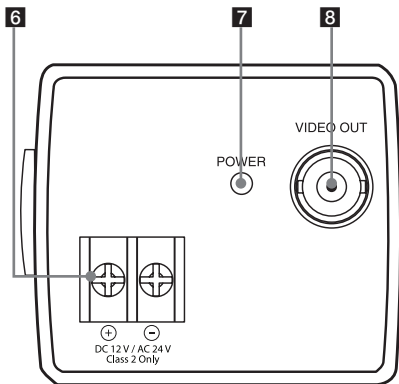

6 Power input terminal

Supplies AC 24 V or DC 12 V from an external power source.

7 Power indicator

Lights when the camera is powered.

8 Video output connector (BNC type)

Supplies analog video signal (composite) to the connected device such as a DVR or monitor.

Connections

Precautions

- Be sure to switch off the unit before installation and connection.
- A qualified service person, complying with all applicable codes, should perform all required hardware installation.
- Do not expose the power and connection cable to moisture, which may cause damage to the unit.

Connection Overview

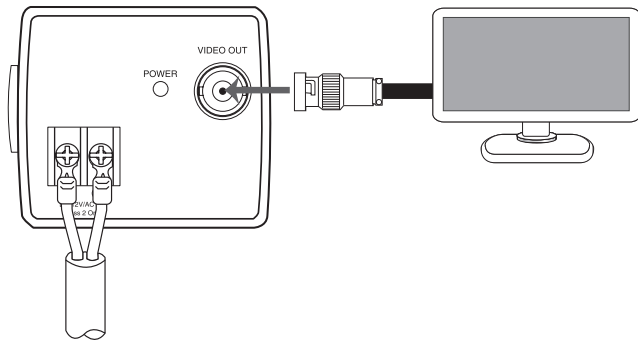

Connections

Connecting Display device

The video signal connection between the camera and the monitor.

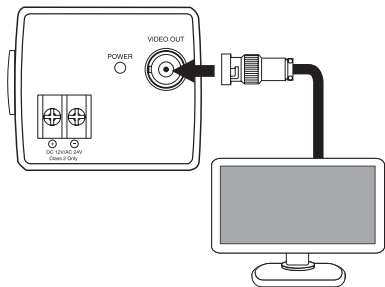

Connecting Power Source

Connect power, using the method listed below:

1. Remove the insulation on the power cable as illustrated. **(1)**
2. Attach the terminal tips. **(2)**
3. Connect to the DC 12 V / AC 24 V UL Listed, Class 2 Power Supply only on the unit.

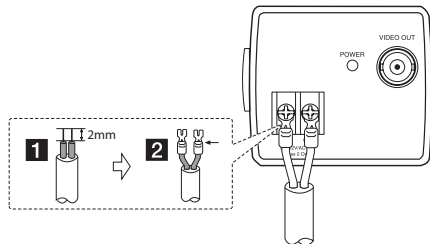

Connections

Mounting the Lens

1. Remove the lens mount cap from the camera.

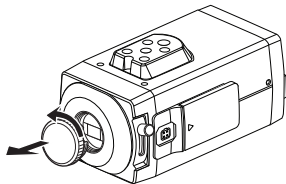

2. Install the auto-iris lens.

2-1. CS mount type lens

Carefully align the lens mount with the camera opening, then turn the lens slowly to install it.

2-2. C mount type lens

To allow for flange- back adjustment, install the C-mount adaptor (option) on the lens mount, then carefully align the lens mount with the camera opening and turn the lens slowly to install it.

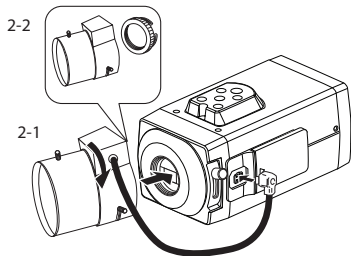

3. Connect the lens plug to the lens iris output connector (LENS) on the side of the camera.

When using lenses from other makers, the plug shape may not correspond to the terminal on the camera.

In such a case, remove the original plug and using a soldering iron, connect a lens iris plug according to the diagram.

Note:

Turn off the camera essentially before the lens connection or replacement.

Connections

Lens iris output connector

Pin layout for the lens iris output connector.

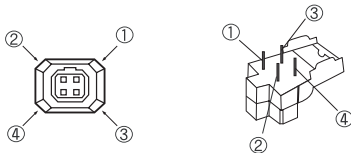

No.	DC type lenses
1	Damping -
2	Damping +
3	Drive +
4	Drive -

Rewire the lens iris plug

1. Cut off the plug of the lens cable, cut off approximately 8 mm of the insulation, and then strip approximately 2 mm of the ends of the cable sheaths.

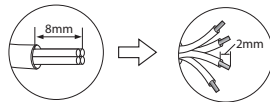

2. Solder the ends of the cable wires to the ends of the pins, and then attach the cover of the lens iris plug.

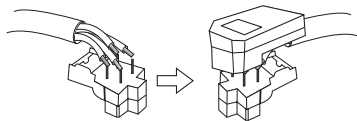

Connections

Flange-back Adjustment

The adjustment is required only when a lens without focus-adjusting mechanism is mounted, or when a lens with adjusting mechanism is mounted and focus that is more accurate is needed.

1. Loosen the flange-back fixing lever.
2. Up and down the flange-back adjusting lever to obtain a focused point while watching the monitor screen.
3. Tighten the flange-back fixing lever.

Note:

The object may be out of focus when using a source of near-infrared light than using the visible light.

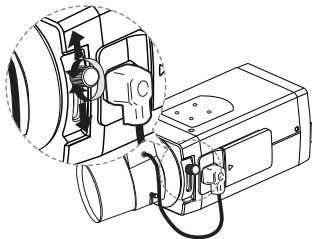

Connections

Mounting the camera

The mounting bracket can be secured on either the top or bottom of the camera. Use the same set of screws to attach the mounting bracket on the camera.

Note:

If using a camera mounting bracket, select a location that is strong enough to bear the full weight of the camera and the mounting bracket for long periods, and install the camera and mounting bracket securely.

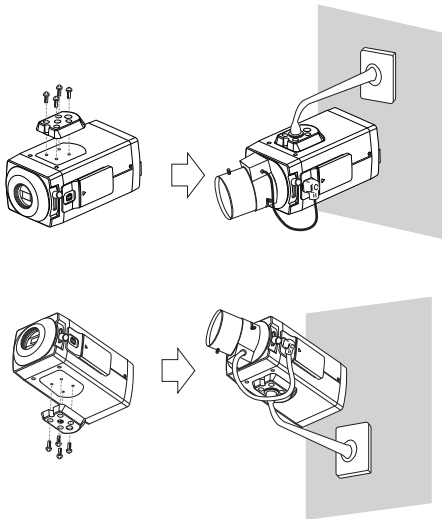





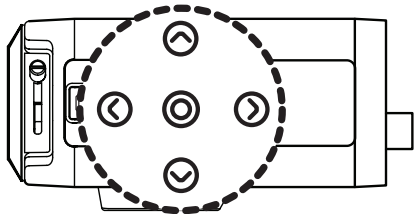

Menu Operation

OSD Menu control buttons

This camera utilizes an on-screen user MENU. To set items on the menu, use the following buttons.



BUTTON	Description
 UP button	Used to move upper direction on the menu screen. Use this button to select an item or adjust the parameters.
 DOWN button	Used to move lower direction on the menu screen. Use this button to select an item or adjust the parameters.
 RIGHT button	Moves the cursor to the right. Used to increment the value selected in the menu. The parameter changes each time this button is pressed.
 LEFT button	Moves the cursor to the left. Used to decrement the value selected in the menu. The parameter changes each time this button is pressed.
 SET button	Executes selections and displays a submenu for an item with the  mark.

Menu Operation

OSD Menu Overview

The following table shows the list of menu items and options. You can adapt the camera to your requirements by setting up the respective items in these menus.

Main Menu	Sub Menu	Contents	
EXPOSURE	ALC /ELC	BACKLIGHT	OFF/BLC/HSBLC
		BRIGHTNESS	0 to 100
		AGC	OFF/LOW/MIDDLE/HIGH
		SHUTTER	x512, ..., x2, AUTO, OFF, A.FLK, 1/160, ..., 1/120 000
		SENS-UP	OFF / AUTO
		EXIT	RET/ TOP/ END
WHITE BAL	ATW	-	
	AUTO	-	
	AWC → SET KET	-	
	MANUAL	RED	-100 to 100
		BLUE	-100 to 100
	EXIT	RET/ TOP/ END	

DAY/ NIGHT	AUTO	BURST	ON/OFF	
		LEVEL	LOW/ MIDDLE/ HIGH/USER	
		DWELL TIME	3 SEC to 60 SEC	
	DAY	-		
	NIGHT	BURST	ON/OFF	
EXIT	RET/ TOP/ END			
MOTION DET	OFF	-		
	ON	AREA SETUP	AREA SELECTION	1 to 8
			STATE	ON / OFF
			POSITION ↔	0 to 7
			POSITION ↑↓	0 to 5
			SIZE ↔	1 to 8
			SIZE ↑↓	1 to 6
	SENSITIVITY	0 to 100		
	DISPLAY	OUTLINE / MASK1 / MASK2 / OFF		
	ALARM OUT	MESSAGE / OFF		
	EXIT	RET/ TOP/ END		
3D-DNR	0 to 100			

Menu Operation

PRIVACY MASK	OFF	-		
	ON	RECTANGLE	MASK SELECTION	1 to 8
			DISPLAY	OFF,MOZAIC, COLOR1 to COLOR 8
			POSITION ←→	2 to 98
			POSITION ↑↓	2 to 98
			SIZE ←→	4 to 100
			SIZE ←→	4 to 100
			EXIT	TOP/RET/END
			CIRCLE	MASK SELECTION
		DISPLAY		OFF,MOZAIC, COLOR1 to COLOR8
		POSITION ←→		0 to 100
		POSITION ↑↓		0 to 100
		SIZE ←→		1 to 15
		SIZE ←→		1 to 15
		RADIOUS		1 to 100
		EXIT		TOP/RET/END

PRIVACY MASK	ON	POLYGON	MASK SELECTION	1 to 2	
			DISPLAY	OFF,MOZAIC, COLOR1 to COLOR 8	
			SHAPE	-	
			POSITION	-	
			EXIT	TOP/RET/END	
		EXIT	TOP/RET/END		
		OFF	-		
SPECIAL	D-ZOOM	ON	ZOOM	x 1.0 to x 16.0	
			PAN	-100 to 100	
			TILT	-100 to 100	
	D-EFFECT		OFF / MIRROR / V-FLIP / ROTATE		
	SHARPNESS		0 to 100		
	COLOR		0 to 100		
	SYNC		INT / LL		
	USER TITLE		ON / OFF		
	LANGUAGE		ENG/CHN/KOR/JAP/FRE/ITA/SPA/POR/DUT/GER/POL/RUS/TUR/ARA/HEB		
	EXIT		RET/ TOP/ END		
SYSTEM	FACTORY RESET		-		
	EXIT		RET/ TOP/ END		
EXIT	RET/ TOP/ END				

Menu Operation

General Operation

1. Press [SET] button.
[CAMERA SETTING] menu appears on the monitor.

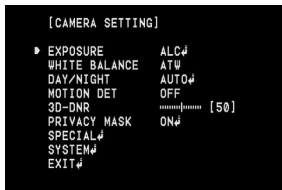

2. Use [UP] or [DOWN] button to select an option then press [SET] button.
Submenu appears on the monitor.
3. Use [UP] or [DOWN] button to select a submenu option.
4. Use [LEFT] or [RIGHT] button to select a value.
5. Select [EXIT] option then press [SET] to exit the setup menu. In the submenu, use [UP] or [DOWN] button to select the [RET] then press [SET] to return to the

previous setup menu.

- RET: Return to the previous.
- TOP: Return to the CAMERA SETTING menu screen.
- END: Exit the setup menu.

Exposure Settings

You can set the exposure options using the EXPOSURE menu.

1. Select [EXPOSURE] option on the [CAMERA SETTING] menu.
2. Use [LEFT] or [RIGHT] button to select a mode.
3. Press [SET] button and the [EXPOSURE] menu appears.

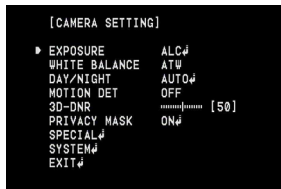

Menu Operation

Backlight setting

Use Backlight option to view the object clearly in backlight conditions.



1. Select [Backlight] option.
2. Use [LEFT] or [RIGHT] button to select a mode then press [SET].
 - BLC: Camera's backlight compensation feature helps alleviate issues of visibility in high contrast areas. Set the BLC limit.
 - HSBL: Use for masking brightness of the specific area to view the subject more clearly. The HSBL mode is automatically activated regardless of Day and Night mode.

- > AREA SETTING: Use [LEFT] or [RIGHT] button to select a area then use [UP] or [DOWN] button to select a [ON] or [OFF]. Press [SET] to exit the Area setting menu.
- > GRAY SCALE: Use [LEFT] or [RIGHT] button to select a gray scale. (GRAY, D.GRAY, BLACK)
- > USER SCALE: Use [LEFT] or [RIGHT] button to select a bright level. (5 level)
- > MASK: Use [LEFT] or [RIGHT] button to select [ON] or [OFF].
If you set the [MASK] to [ON], the mask function is activate only when the [HSBLC] is automatically activated in low luminance scene.

- OFF: Not used.

Menu Operation

BRIGHTNESS setting

You can increase the brightness of the darkened video. If you set the brightness to lower value, the image is darkened. If you set the brightness to higher value, the image gets bright.



1. Select [BRIGHTNESS] option.
2. Use [LEFT] or [RIGHT] button to set the bright level.

AGC (Automatic Gain Control) setting

If the images are too dark, change the maximum [AGC] value to make the images brighter. But noise is increase.

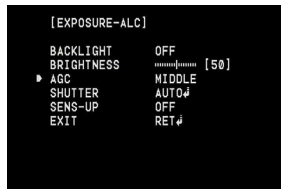

1. Select [AGC] option.
2. Use [LEFT] or [RIGHT] button to select a mode.

Menu Operation

SHUTTER (Shutter Speed) setting

Select the desired shutter speed for camera exposure. You can change the shutter speed to higher speed to capture fast-moving subjects, though the image becomes darker.

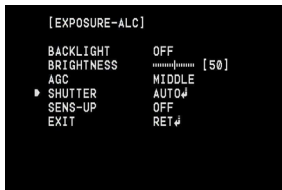

1. Select [SHUTTER] option.
2. Use [LEFT] or [RIGHT] button to set shutter speed.
 - AUTO: Adjust the [LOW LIMIT] and [HIGH LIMIT].
 - > LOW LIMIT: Use [LEFT] or [RIGHT] button to set the [LOW LIMIT].
 - > HIGH LIMIT: Use [LEFT] or [RIGHT] button to set the [HIGH LIMIT].

Note:

When the SHUTTER is set to AUTO, the picture may become unstable if the camera faces a bright fluorescent light directly. Therefore, take care when installing.

SENS-UP setting

If pictures are not clear due to darkness, this SENS-UP operation would increase the sensitivity of picture.



1. Use [UP] or [DOWN] button to select [SENS-UP] option.
2. Use [LEFT] or [RIGHT] button to select mode.
 - AUTO: Adjust the sensitivity of the picture automatically.

Menu Operation

- > SENS-UP LIMIT: Use [LEFT] or [RIGHT] button to set the SENS-UP limit.
- OFF: Not used.

Note:

If you set to one of the [SHUTTER] options except [AUTO] on the [SHUTTER] menu, the [SENS-UP] setting is not available and [---] mark is displayed.

White Balance settings

Select the method by which the camera shifts its output colors to compensate for the color of a light source.

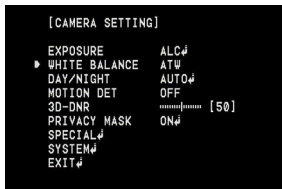

1. Select [WHITE BAL] option.
2. Use [LEFT] or [RIGHT] button to select a mode then press [SET].
 - ATW (Auto-Tracing White Balance): Use [LEFT] or [RIGHT] button to select the ATW.
 - AUTO : Use [LEFT] or [RIGHT] button to select the [AUTO].
 - AWC➡SET KEY: If you select the [AWC➡SET KEY] mode, you will be able to set up the White Balance automatically.
 - MANUAL: You can set the white balance options manually. Push the [AWC➡SET KEY] mode, and then adjust White Balance. You can set the RED and BLUE in the [MANUAL] mode.
 - > RED: Obtains the optimum amount of red gain.
 - > BLUE: Obtains the optimum amount of blue gain.

Menu Operation

Day & Night Setting

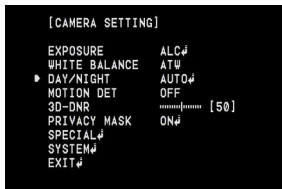

1. Select [DAY/NIGHT] option.
2. Use [LEFT] or [RIGHT] button to select mode for Day/Night function.
 - AUTO: You will be able to change the Day/Night mode automatically.

Note:

If you set the AGC to [OFF] on the [EXPOSURE] menu, the AUTO mode of the DAY/NIGHT function is not available and [---] mark is displayed.

- > BURST: Use [LEFT] or [RIGHT] button to

select [ON] or [OFF].

- > LEVEL: Use [LEFT] or [RIGHT] button to select a level.
- > DWELL TIME: Use [LEFT] or [RIGHT] button to select a dwell time.
- DAY: Color mode enabled.
- NIGHT: Black-and-white mode enabled.
- > BURST: Use [LEFT] or [RIGHT] button to select [ON] or [OFF].

Menu Operation

Motion Detection Setting

The motion detection detects the moving objects in the scene by monitoring changes in brightness level. You can select the level of sensitivity for motion detection to 8 zone.

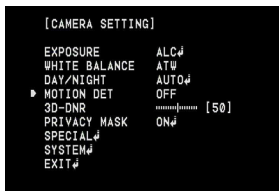

1. Select [MOTION DET] option.
2. Use [LEFT] or [RIGHT] button to select a [ON] and press [SET]. The [MOTION DETECTION] menu appears.
3. Select [AREA SETUP] option.
 - Use [LEFT] or [RIGHT] button to select a area on the [AREA SELECTION].
 - Use [LEFT] or [RIGHT] button to set up the [ON] or [OFF] on the [STATE].
- Use [UP] or [DOWN] to select an option then use [LEFT] or [RIGHT] button to adjust the option.
 - > POSITION \leftrightarrow : Moves horizontal position of the mask.
 - > POSITION \updownarrow : Moves vertical position of the mask.
 - > SIZE \leftrightarrow : Enlarge or decrease the horizontal size of the mask.
 - > SIZE \updownarrow : Enlarge or decrease the vertical size of the mask.
4. Use [SENSITIVITY] option to obtain the optimum detection level.
5. Use [LEFT] or [RIGHT] button to select the [DISPLAY] option.
6. Use [LEFT] or [RIGHT] button to select the [ALARM OUT] option.

Menu Operation

3D-DNR Setting

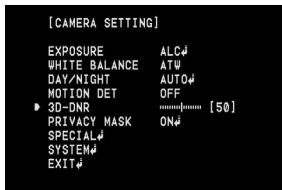

1. Select [3D-DNR] option.
If pictures are not clear due to brightness, this option would reduce the noise of picture.
2. Use [LEFT] or [RIGHT] button to select a value.

Privacy Mask Setting

This function is aiming at the protection of personal privacy, selecting a screen part black not to be displayed in the screen. Up to 14 zones can be registered.

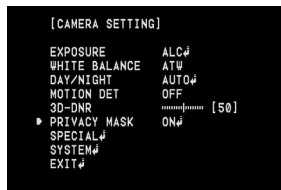

1. Select [PRIVACY] option.
2. Use [LEFT] or [RIGHT] button to select a [ON] and press [SET]. The PRIVACY SETUP menu appears.
 - RECTANGLE :
 - > Use [LEFT] or [RIGHT] button to select a mask on the [MASK SELECTION].
 - > Use [LEFT] or [RIGHT] button to set up the [DISPLAY] option.

Menu Operation

- > Use [UP] or [DOWN] to select an option then use [LEFT] or [RIGHT] button to adjust the option.
 - POSITION \leftrightarrow : Moves horizontal position of the mask.
 - POSITION \updownarrow : Moves vertical position of the mask.
 - SIZE \leftrightarrow : Enlarge or decrease the horizontal size of the mask.
 - SIZE \updownarrow : Enlarge or decrease the vertical size of the mask.
 - CIRCLE :
 - > Use [LEFT] or [RIGHT] button to select a mask on the [MASK SELECTION].
 - > Use [LEFT] or [RIGHT] button to set up the [DISPLAY] option.
 - > Use [UP] or [DOWN] to select an option then use [LEFT] or [RIGHT] button to adjust the option.
 - POSITION \leftrightarrow : Moves horizontal position of the mask.
 - POSITION \updownarrow : Moves vertical position of the mask.
 - SIZE \leftrightarrow : Enlarge or decrease the horizontal size of the mask.
 - SIZE \updownarrow : Enlarge or decrease the vertical size of the mask.
 - POLYGON :
 - > Use [LEFT] or [RIGHT] button to select a mask on the [MASK SELECTION].
 - > Use [LEFT] or [RIGHT] button to set up the [DISPLAY] option.
 - > Use the [LEFT], [RIGHT], [UP], [DOWN], [SET] button to draw the polygon on the [SHAPE].
 - > Use the [LEFT], [RIGHT], [UP], [DOWN], [SET] button to move the polygon on the [POSITION].
- Notes:**
- You can adjust the mask color manually except for COLOR 8.
 - RED, GREEN, BLUE and TRANSPARENCY

Menu Operation

adjustments are applied in common from COLOR 1 to COLOR 7, after mask setting.

Special Menu Settings

This menu lets you adjust and set up D-ZOOM, D-EFFECT, SHARPNESS, COLOR, SYNC, USER TITLE, LANGUAGE function by yourself in the [SPECIAL] menu.

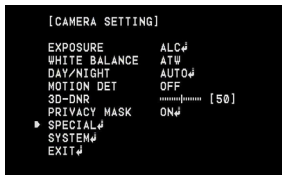

1. Select [SPECIAL] option.
2. Press [SET] button and the [SPECIAL] menu appears.

D-ZOOM (Digital Zoom) Setting

You can select the digital zoom level.



1. Select [D-ZOOM] option on the [SPECIAL] menu.
2. Use [LEFT] or [RIGHT] button to select a [ON] then press [SET] the DIGITAL ZOOM menu appears. When you set to ON, the displayed image can be shaking.
3. Use [UP] or [DOWN] to select a option then use [LEFT] or [RIGHT] button to select a level.
 - ZOOM: Use [LEFT] or [RIGHT] button to enlarge the screen.
 - PAN: Use [LEFT] or [RIGHT] button to move the screen.

Menu Operation

- TILT: Use [LEFT] or [RIGHT] button to move the screen.

Note:

If you set the [D-ZOOM] to [ON], the ZOOM level is set to [x1.0] automatically.

D-EFFECT (Digital effect) Setting

You can select the digital effect.



1. Select [D-EFFECT] option on the [SPECIAL] menu.
2. Use [LEFT] or [RIGHT] button to select a digital effect.
 - MIRROR: Turn on the mirror effect.
 - ROTATE: Rotate the picture. (180°)

- V-FLIP: Flip the picture vertically.
- OFF: Turn off the digital effect.

SHARPNESS Setting

The degree to which the boundary of the two portions is clearly distinguished.



1. Select [SHARPNESS] option on the [SPECIAL] menu.
2. Use [LEFT] or [RIGHT] button to change a adjust the option. If you set the sharpness value to higher, the image outline becomes sharp. If you set to lower value, the image outline becomes dim.

Menu Operation

COLOR Setting

You can switch the displayed picture to gray scale or color.



1. Select [COLOR] option on the [SPECIAL] menu.
2. Use [LEFT] or [RIGHT] button to change a adjust the option.

SYNC Setting



1. Select [SYNC] option on the [SPECIAL] menu.
2. The [SYNC] option is set to [INT] automatically.

Note:

AC24V Adaptor have to use for the [LL] mode setting.

Menu Operation

USER TITLE Setting

You can use the camera identification to assign a number and character to the camera. To disappear the user title, select [OFF].

1. Select [USER TITLE] option on the [SPECIAL] menu.
2. Use [LEFT] or [RIGHT] button to select a [ON] then press [SET]. The USER TITLE menu appears.



3. Use [UP], [DOWN], [LEFT] or [RIGHT] button to select a character or number then press [SET] button.
 - CLR: Clear all entered characters and numbers.
 - POS: Move the USER TITLE position on the screen using the arrow buttons.
 - END: Confirm your selection or exit the setting
 - **1** (Blank): Inserts a space at the cursor position.

- / : Moves cursor to left or right.

LANGUAGE Setting

Select the viewer language for the camera setup menu and OSD information display.



1. Select [LANGUAGE] option on the [SPECIAL] screen.
2. Press [LEFT] or [RIGHT] button to select a language.

Menu Operation

SYSTEM Setting

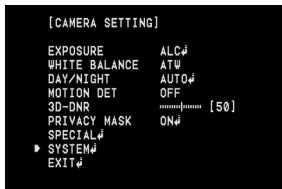

1. Select the [SYSTEM] menu.
2. Press [SET] button and the [SYSTEM] menu appears.
3. Use [UP] or [DOWN] button to select the option.
 - **FACTORY RESET:** To reset the camera setting to factory setting, select the [FACTORY RESET] option.
4. Press [SET] button to confirm your selection.

Specification

Item	LCB5100-BN	LCB5100-BP
Signal System	NTSC	PAL
Total Pixels number	520 000 Pixels	610 000 Pixels
Effective Pixels number	480 000 Pixels	570 000 Pixels
Image Sensor	6 mm (1/3 Type) Exview HAD II CCD	
ISP	XDI-V	
Lens	C/CS Mount	
Horizontal Resolution	650 TV Lines (Color), 700 TV Lines (B/W)	
S/N Ratio	50 dB	
Day & Night	Digital (AUTO / DAY / NIGHT)	
Sens-up	OFF / AUTO(x2, ... x512) /MANUAL(x2, ... x512)	
Minimum Illumination (F1.2, 30 IRE)	0.03 lx (Sens-up Off), 0.0003 lx (Sens-up Auto), 0.000 001 (Sens-up x512)	
White Balance	ATW / AUTO / AWC → SET KEY /MANUAL	
Digital Zoom	X16	
IRIS Control	DC	
Scanning Frequency (H/V)	15.734 kHz / 59.94 Hz	15.625 kHz / 50 Hz
Sync. System	Internal / Line Lock	
Auto Gain Control	OFF/ LOW/ MIDDLE/ HIGH	
Exposure	ALC / ELC	

Specification

Item	LCB5100-BN	LCB5100-BP
Video Output	1 Vp-p Composite (75 Ω)	
Electronic Shutter	1/60 to 1/120 000	1/50 to 1/120 000
Backlight Compensation	BLC / HSBLC / OFF	
Motion Detection	8 Zones	
Privacy Masking	14 Mask Zones	
DNR	2D + 3D-DNR	
Digital Effect	OFF / MIRROR / V-FLIP / ROTATE	
Control Method	Coaxial Communication	
Power Source	DC 12 V / AC 24 V	
Power Consumption	240 mA	
Operating Temperature/ Humidity	-10 °C to 50 °C / 0 % RH to 80 % RH	
Storage Temperature/ Humidity	-20 °C to 60 °C / 0 % RH to 85 % RH	
Dimension (W x H x D)	67.36 mm x 61.50 mm x 133.90 mm	
Weight	362 g	

