



NTI® NETWORK
TECHNOLOGIES
INCORPORATED

1275 Danner Dr Tel:330-562-7070
Aurora, OH 44202 Fax:330-562-1999
www.networktechinc.com

RACKMUX® Series

RACKMUX-V17-N-8/4USBHDU(-IP)

Rackmount KVM Drawer with Built-In High Density USB KVM Switch and KVM on IP™ Installation Manual



RACKMUX-V17-N-8/4USBHDU(-IP)
(Front and Rear View)

TRADEMARK

RACKMUX is a registered trademark of Network Technologies Inc in the U.S. and other countries.

COPYRIGHT

Copyright © 2011, 2013 by Network Technologies Inc. All rights reserved. No part of this publication may be reproduced, stored in a retrieval system, or transmitted, in any form or by any means, electronic, mechanical, photocopying, recording, or otherwise, without the prior written consent of Network Technologies Inc, 1275 Danner Drive, Aurora, Ohio 44202.

CHANGES

The material in this guide is for information only and is subject to change without notice. Network Technologies Inc reserves the right to make changes in the product design without reservation and without notification to its users.

Typographic Conventions

The following table describes the typographic changes used in this instruction.

Typeface	Meaning	Example
AAaaBBaaCCcc123	On-screen computer output	C:>
AAaaBBaaCCcc123	What you type, contrasted with on-screen computer output; keyboard keys to press	C:> L Press the Fn key

TABLE OF CONTENTS

Introduction.....	1
Materials Included:.....	1
Materials <i>Not</i> Supplied, but <i>REQUIRED</i>	1
RACKMUX Single-Person Installation	2
Cable Connections	6
Connect CPUs	6
Login to USB KVM Switch	7
Password and User Name.....	7
Connect CAC Card Reader	8
Remote PC Connection	9
Features and Functions.....	12
Display Functions	13
Standard Controls	13
OSD Control Menu- 15 and 17 Inch VGA models (-V15/-V17)	13
OSD Main Menu	13
Brightness/Contrast Menu	14
Color Menu	14
Position Menu	14
Setup Menu.....	15
OSD Control Menu-DVI Model (-D17)	15
OSD Main Menu	15
Brightness/Contrast Menu	16
Setup Menu.....	16
OSD Control Menu- 17 Inch Hi-Resolution Model (-HR).....	17
OSD Main Menu	17
Keyboard Functions	19
Function Key Operation	19
Numeric Keypad Option.....	20
PS/2-USB Keyboard/Mouse Mode	21
USING THE UNIMUX USB KVM SWITCH	22
Basic Operation	22
OSD Control	22
OSD CONTROL.....	23
Guidelines for Navigating OSD Menus.....	23
Security Option	23
Initial startup	24
User Access Functions	24
Command Mode	24
Settings	26
OSD Settings	27
Find Mode	27
Help Mode.....	28
Scan Mode.....	28
Broadcast Mode.....	29
Normal Mode	29
Security	30
Enabling Security.....	30
Password and User Name.....	30
User Login.....	31
Additional OSD Modes Available With Security Enabled	31
Administration Menu	31
System Configuration	32
Port Configuration	32
User Configuration.....	33
Edit User Account.....	33

User Access Control	34
Change Administrator Password	34
Display Usage	35
Ethernet Configuration	35
Idle Timeout	36
OSD Blank Timeout	36
Alternate Command Hot Key	37
Reset Port names	37
Select Keyboard Language	38
Security Configuration	38
Serial Baud Rate	39
Serial Address	40
Keyboard Mapping	41
Key Equivalents	41
Mouse Click Equivalents	41
SUN's 16 Extra Keys	41
RS232 CONTROL	43
Remote Connection	43
Baud Rate	43
Unit Address and Loop Back	43
RS232 Command Protocol	45
RS232 Command Protocol Quick Reference	45
Autostatus	45
NTI Switch Control Program For Windows 9X, NT, 2000, XP and Vista	46
SerTest- RS232 Interface Test Program	47
Main Options	47
Matrix Operations	47
Setup Options	47
RMTEST-RS232 Interface Test Program	48
SUN RAY SUPPORT	49
FIRMWARE UPGRADE PROCEDURE	50
Requirements	50
Preparation For Upgrade	51
Upgrade Procedures	52
Start the Bootloader	52
Update the User Controller Firmware	53
Update the HID Port Controller Firmware	53
Update the Vendor Specific Port Controller Firmware	54
Read the Checksum of HID or Vendor Specific Port Controller Firmware	55
SAFETY	56
Rackmux-KVM Drawer Standard Specifications	57
General Specs	57
LCD – 17"	57
Display Controller: VGA	57
OSD Control Board	57
Keyboard	57
Touchpad	58
Troubleshooting For KVM Drawer	59
Index	59
Warranty Information	60

TABLE OF FIGURES

Figure 1- Adjustable rail assemblies	2
Figure 2- Install the cage nuts.....	3
Figure 3- Install the rail assemblies	3
Figure 4- Check spacing of the rails	4
Figure 5- Rail guides.....	4
Figure 6- Apply remaining screws to complete installation	5
Figure 7- Connect each CPU using a HDUSBVEXT-xx-MM cable	6
Figure 8- USB KVM Switch OSD Splash Screen.....	7
Figure 9- User login screen.....	7
Figure 10- Install CAC card reader	8
Figure 11- Connect Remote PC to KVM on IP at "LAN" port.....	9
Figure 12- Login Screen for KVM on IP	9
Figure 14- Network Configuration screen	10
Figure 15- Remote Console Preview	11
Figure 16- OSD Controls	13
Figure 17- US(English) Keyboard Layout	19
Figure 18- Keyboard LED Indications	19
Figure 19- U.S. (English) keyboard with numeric keypad	20
Figure 20- U.K. (English) keyboard with numeric keypad	20
Figure 21- German keyboard with numeric keypad	21
Figure 22- Command Mode main menu-User.....	25
Figure 23- Administrator's main menu	26
Figure 24- Settings menu.....	26
Figure 25- OSD Settings screen	27
Figure 26- Find Mode in use	27
Figure 27- Main Menu help screen	28
Figure 28- Scan List.....	28
Figure 29- Broadcast List.....	29
Figure 30- User login screen.....	30
Figure 31- Administrator's main menu	30
Figure 32- User Login screen with security disabled	31
Figure 33- Administration Mode Menu.....	31
Figure 34- System Configuration menu	32
Figure 35- Port Configuration menu.....	32
Figure 36- User Configuration.....	33
Figure 37- User Account menu	33
Figure 38- Access Control list	34
Figure 39- Administrator password menu	34
Figure 40- Usage Statistics Page	35
Figure 41- Ethernet Configuration.....	35
Figure 42- Change value of Idle Timeout.....	36
Figure 43- Change the value of OSD Blank Timeout.....	36
Figure 44- Alternate Command Hot Key selection window	37
Figure 45- Press "R" to reset port names	37
Figure 46- Select Language menu.....	38
Figure 47- Security Configuration	38
Figure 48- Login screen with security disabled	39
Figure 49- Adjust Baud Rate.....	39
Figure 50- Adjust Serial Address	40
Figure 51- Keyboard layouts.....	42
Figure 52- RS232 connection with Matrix-Y-1 cable.....	44
Figure 53- Pinout of Matrix-Y-1 cable	44
Figure 54- Preparation for firmware upgrade	51

INTRODUCTION

The RACKMUX® KVM Drawer with Built-In High Density USB KVM Switch combines a rackmount LCD monitor, keyboard, touchpad mouse, a 4, 8 or 16-port USB switch.

Option: Include a KVM on IP device for remote access to the KVM switch and connected PCs- just add “-IP” to part number (i.e. RACKMUX-V17-N-8USBHD-IP)

Option: USB device port for connection of a CAC card reader- add a “U” to the model number (RACKMUX-V17-N-8USBHDU)

Features Include:

- Available with forward-folding 17" TFT/LCD VGA monitor.
 - 1280x1024 video resolution for 17" monitor.
 - Tilt LCD up and back to adjust to any comfortable viewing angle to 120°
- Compatible with USB computers.
- Remotely access multiple computers connected to the USB KVM Switch using a standard Internet browser.
- Securely gain BIOS level access to systems for maintenance, support, or failure recovery over the Internet.
- Torque-friction hinges – monitor does not wobble, spring, or slam shut.
- Compact, heavy-duty tactile keyboard with 17-key numeric keypad.
- Drawer locks into place when open to prevent it from sliding in and out of the rack.
 - Front quick-release latches for pushing the drawer back into the rack.
- Rugged steel construction with durable powder coat finish.
- LCD auto-shutoff in closed position.
- Optional KVM on IP™ requires no client software. Secure connections can be made with any browser.

Materials Included:

- RACKMUX-V17-N-4/8/16USBHD KVM Drawer
- IEC Power cord- country specific
- Rackmount kit
- DB9 Female-to-RJ45 Female adapter
- DB25 Female-to-RJ45 Female adapter
- 5 foot RJ45-to-RJ45 CAT5 patch cable
- CAT5-CO-MF Crossover Adapter
- CD with PDF file of this manual, RS232 control software, and more

Materials Not Supplied, but **REQUIRED**

- HDUSBVEXT-xx-MM cable for each CPU being connected to the switch

Where:

xx is the length of the cable in feet (3,6,10, or 15 feet available)

MM indicates male-to-male connector

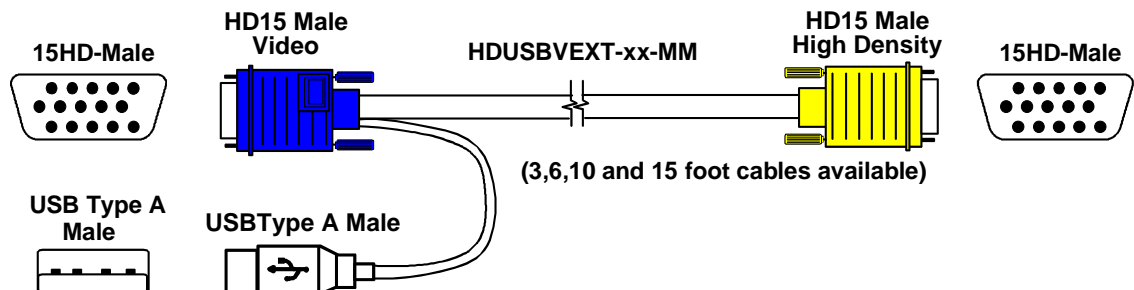

Cables can be purchased from Network Technologies Inc by calling 800-RGB-TECH (800-742-8324) or 330-562-7070 or by visiting our website at www.networktechinc.com.

RACKMUX SINGLE-PERSON INSTALLATION

Your NTI RACKMUX Drawer was designed for easy installation by one person with a minimum of tools and effort. Follow the simple steps below to quickly install your RACKMUX Drawer.

If you would like to see a video of this installation, see the link on the page that opens when you insert the CD that accompanied your RACKMUX, or open **single-person-installation.mp4** on the CD.

1. Locate and unpack the hardware bag. Your hardware bag will include all items necessary to install the specific RACKMUX model (see the manual that accompanied your RACKMUX drawer), including the following hardware unique to the Single-Person hardware installation:

- 10- #10-32 cage nut
- 2- #10-32 x 1/2" flat-head machine screw
- 8- #10-32 x 3/4" pan-head machine screw



To install the rails you will need only a tape measure and Phillips screwdriver.

2. Unpack the left and right rail assemblies. Each are labeled "Right Front" and "Left Front" to indicate their intended position and orientation. Extend each rail assembly to the dimension required for your rack. Rail assemblies are adjustable to fit within a rack between 24" and 40" in depth.

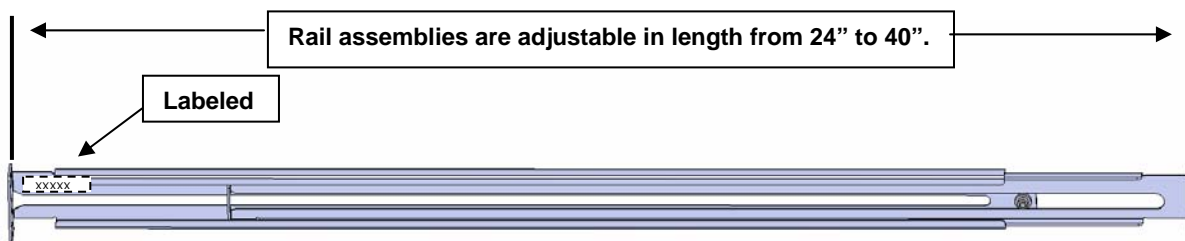

Figure 1- Adjustable rail assemblies

3. Install six #10-32 cage nuts at the front of the rack in positions where the RACKMUX will be mounted (three in each side). Install four more cage nuts at the rear of the rack in positions straight across from the upper and lower cage nuts installed in front.

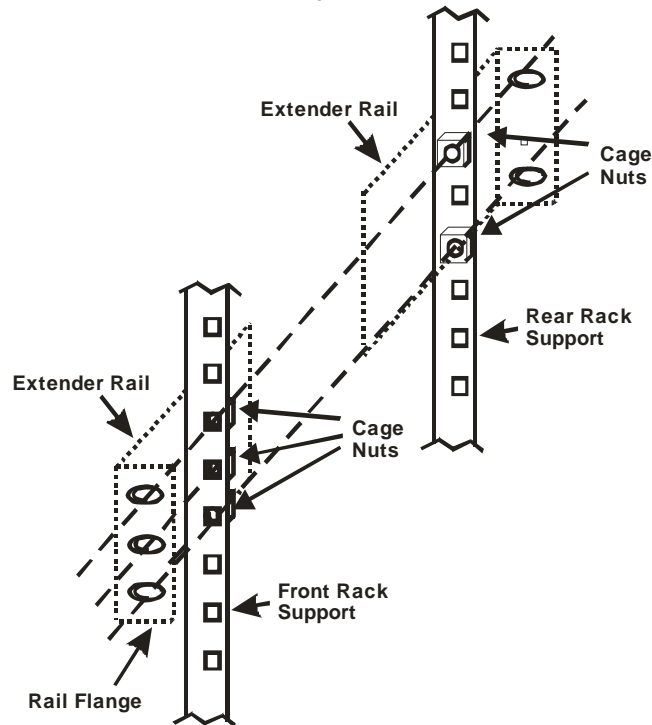

Figure 2- Install the cage nuts

4. Install the right rail assembly. The end with the label “Right Front” mounts to the front rack support. Install only the center screw through the rail flange to the rack support and cage nut using the #10-32 x 1/2” flat head machine screw provided. (See image below.) Do not tighten at this time. Install the left rail assembly in the same fashion. The end with the label “Left Front” mounts to the front rack support.

5. Install two #10-32 x 3/4” pan-head screws in the rear of each rail assembly as shown below. Do not tighten at the time.

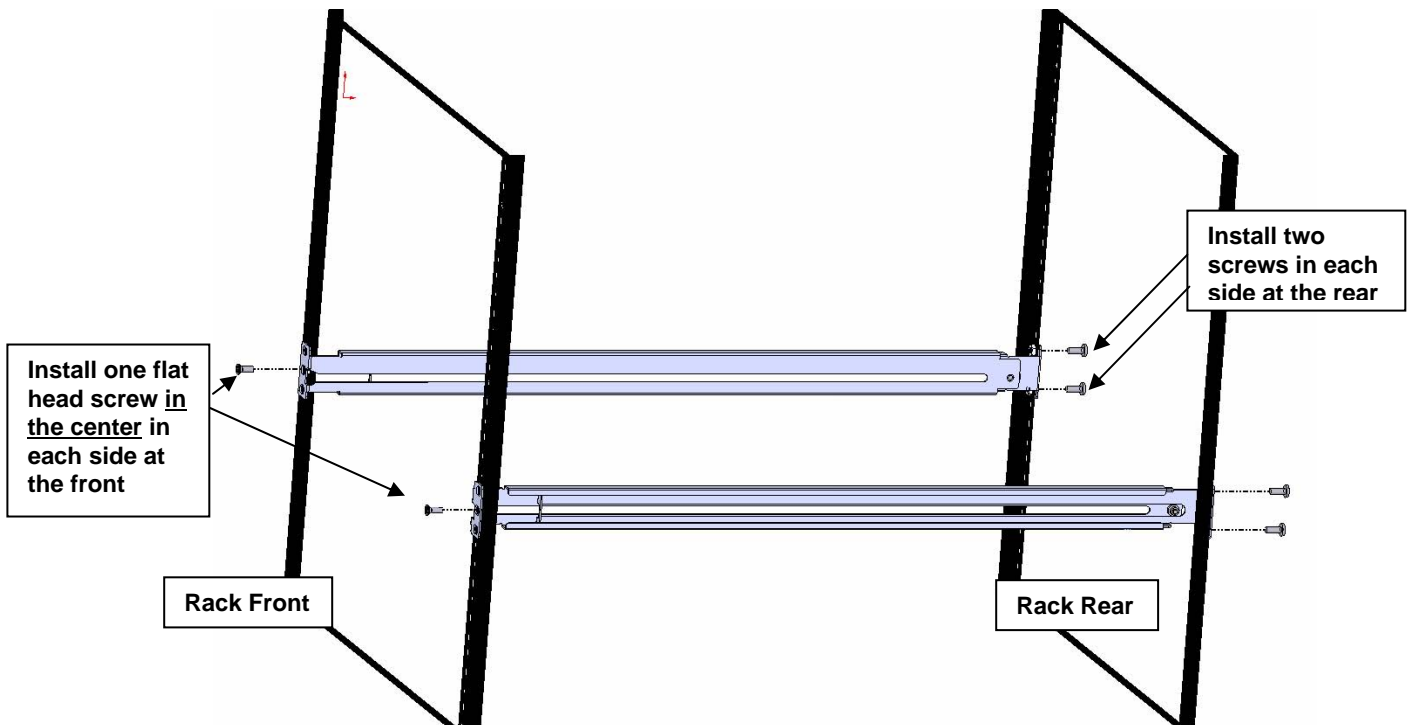

Figure 3- Install the rail assemblies

6. Measure the distance between the inside of the rails at the front of the rack. Adjust the distance to 17-1/4" and tighten the flat-head screws to the rail flanges securely.

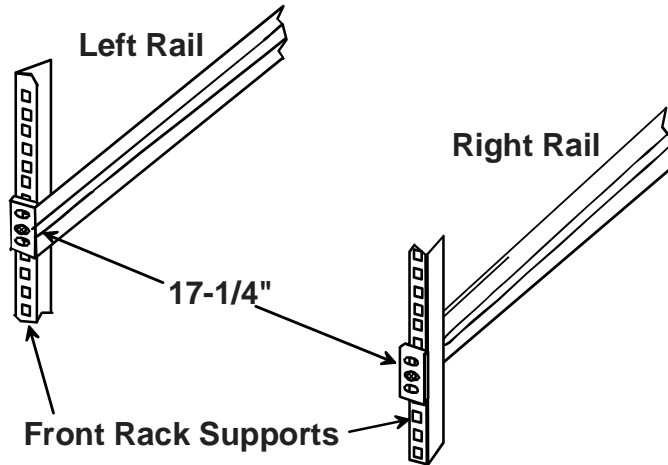
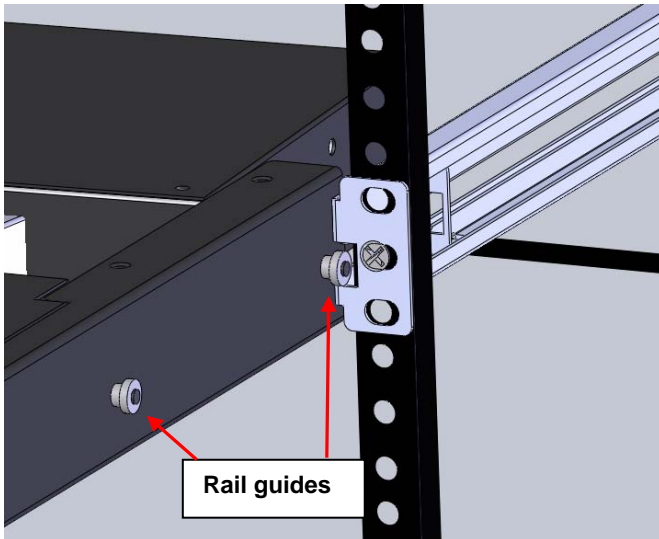
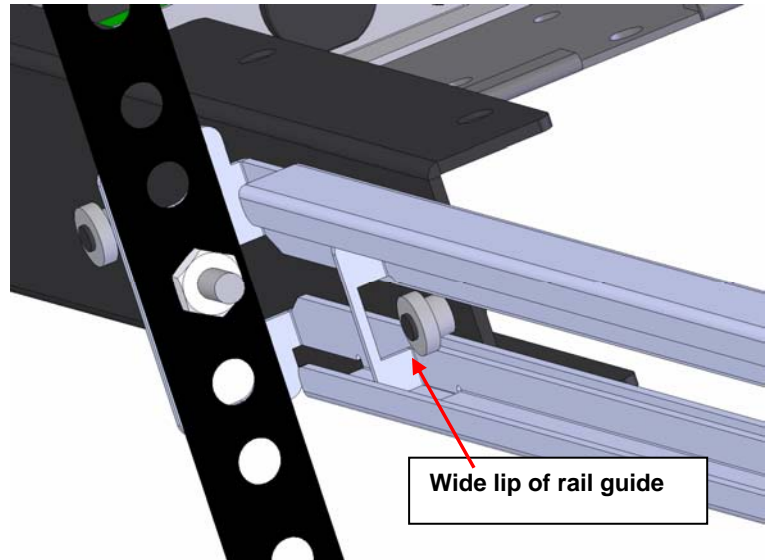

Figure 4- Check spacing of the rails

7. Lineup the rail guides on the RACKMUX drawer with the slots in the front of the left and right rails and slide the drawer into the rack. The rail guides should be positioned such that the wide lip of the guide is on the backside of the rail. Slide the drawer in completely.



View of rail guide from the front of the rack support



View of rail guide from the backside of the rail

Figure 5- Rail guides

8. Apply four more #10-32 x 3/4" pan-head machine screws (two for each) through the holes in the drawer flanges, through the holes in the left and right rails, into the cage nuts in the rack supports. Tighten each securely.

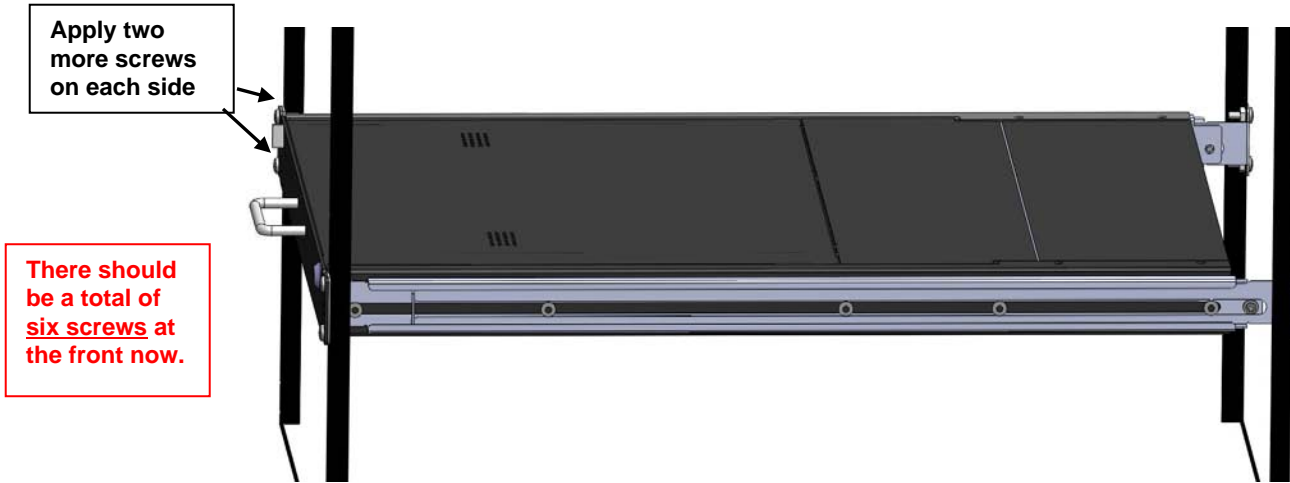

Figure 6- Apply remaining screws to complete installation

9. Tighten securely the four screws applied to the rear rail flanges in step 4.
10. Make your cable connections according to your RACKMUX Drawer instructions.

Your NTI RACKMUX Drawer is now installed and ready for use.

CABLE CONNECTIONS

Connect CPUs

1. For each CPU:

- Connect a USB type A cable end of a HDUSBVEXT-xx-MM cable to a USB type A female user device port on a CPU.
- Connect the 15HD blue male cable end of a HDUSBVEXT-xx-MM cable to the video port of the same CPU.
- Connect the 15HD yellow male cable end of the HDUSBVEXT-xx-MM cable to a yellow “CPU x” port on the USB KVM switch. (See Figure 7)

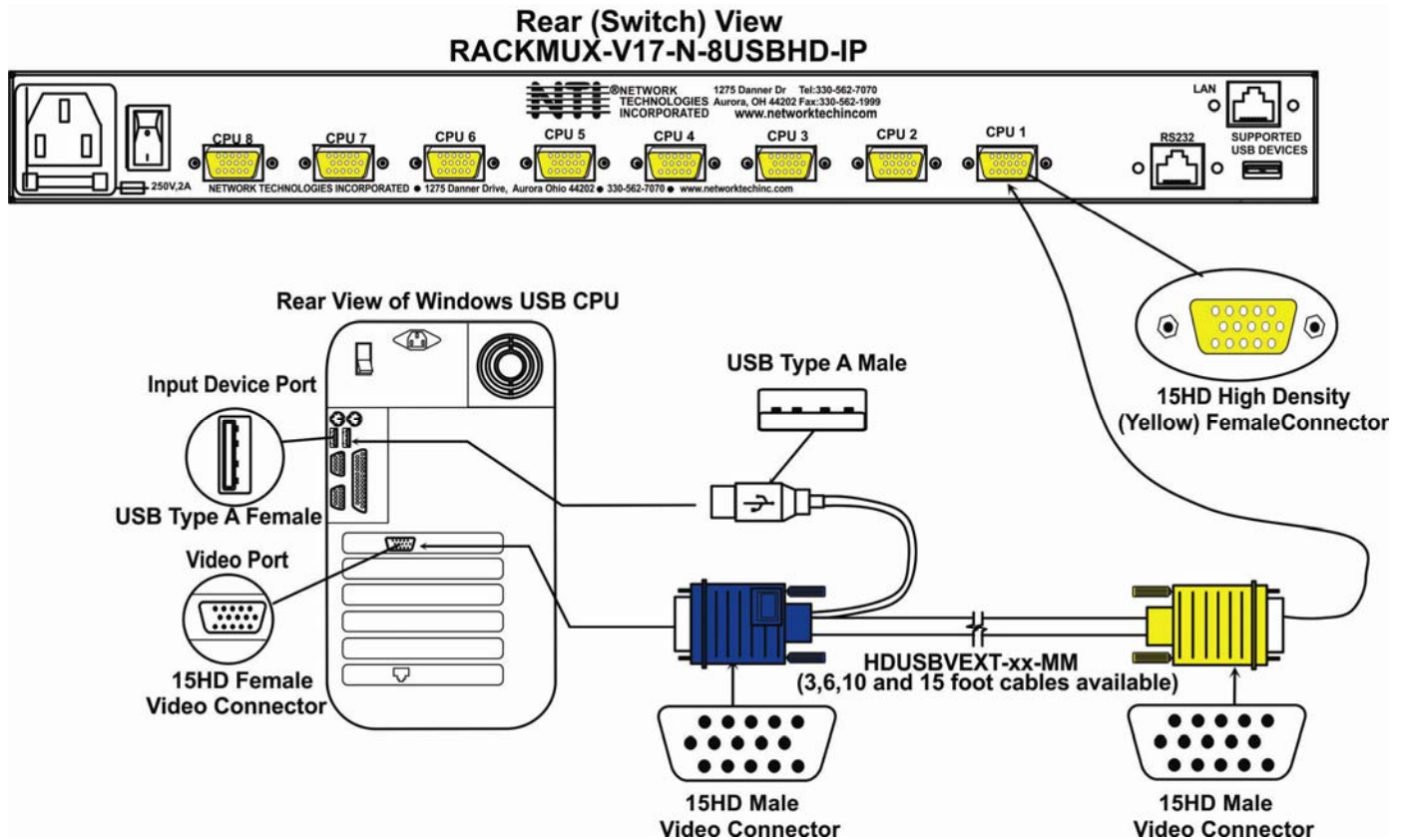

Figure 7- Connect each CPU using a HDUSBVEXT-xx-MM cable

2. Power-ON the CPUs.

- The CPUs can be powered at any time although if a CPU needs a keyboard and/or mouse at power-ON it should be powered after connecting to and powering-ON the RACKMUX.

Note: The order in which the CPUs and switch are powered up does not matter. A power strip can be used.

3. Power-ON the RACKMUX. (The RACKMUX can be powered at any time.)

Login to USB KVM Switch

Immediately after powering ON the RACKMUX, the OSD splash screen shown below will appear on the monitor if the RACKMUX keyboard is in USB mode (see page 20) :

If the OSD Splash screen does not display, press <Ctrl> + <`> (accent/tilde key). The OSD menu will automatically appear on the monitor.

If the security option is enabled, when the UNIMUX is powered up the user will be prompted for a username and password to continue. If the security option is not enabled the monitor will display the desktop image for the connected CPU and the user can continue with normal operation of the connected CPU.

Press any key to open the Command Mode menu.



Figure 8- USB KVM Switch OSD Splash Screen

If security is enabled and you are prompted for a name and password, login as the administrator.

Password and User Name

The factory settings are:

- default user name = <root>
- default password = <nti>

Note: The username for the administrator cannot be changed from "root".



Figure 9- User login screen

After login the Command Mode menu will open and the USB KVM Switch will be ready to configure and use. For more details on the use of the USB KVM Switch, RS232 Control and more, see man039.pdf entitled "UNIMUX-USBV-xHD High Density USB KVM Switch Installation and Operation Manual" on the Product Manual CD.

Note: The RS232 connector on the USB KVM switch is connected and used as described in the UNIMUX-USBV-xHD manual. It is not used as described in the KVM-IP manual that is also included with this product. The RS232 port referred to in the KVM-IP manual is not accessible and therefore not applicable to this product.

Connect CAC Card Reader

If the RACKMUX you have purchased includes the USB port option (RACKMUX-V17-N-8USBHDU), then it supports the connection of a CAC card reader. When used, the CAC card reader will connect to the PC attached to the selected "CPUx" port.

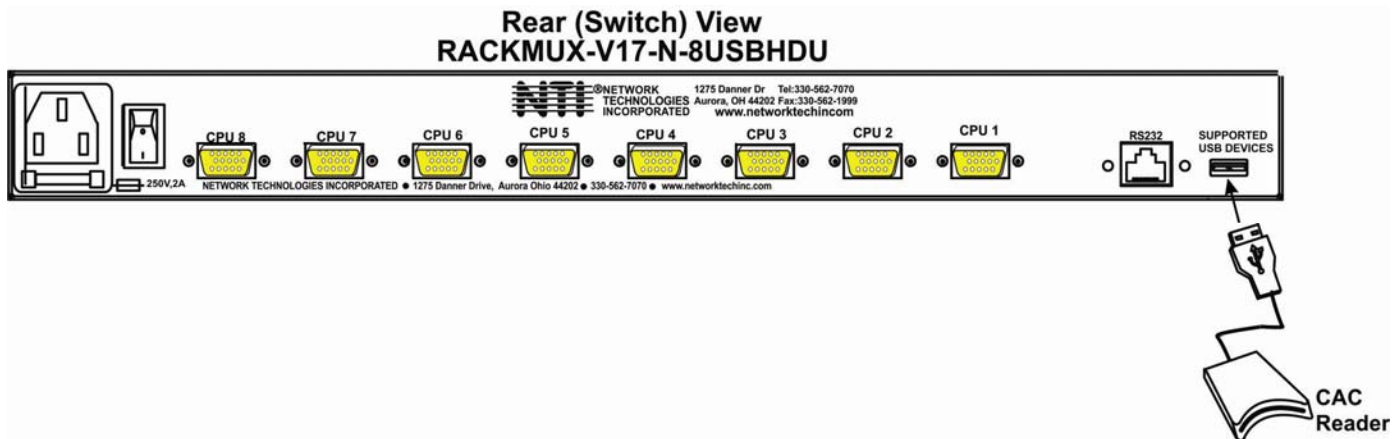

Figure 10- Install CAC card reader

Remote PC Connection

If the KVM on IP option was purchased (RACKMUX-V17-N-8USBHD-IP):

1. Make a connection between an available RJ45 Ethernet port on a PC and the "LAN" port on the RACKMUX switch. A five foot patch cable and crossover adapter have been included for this purpose.

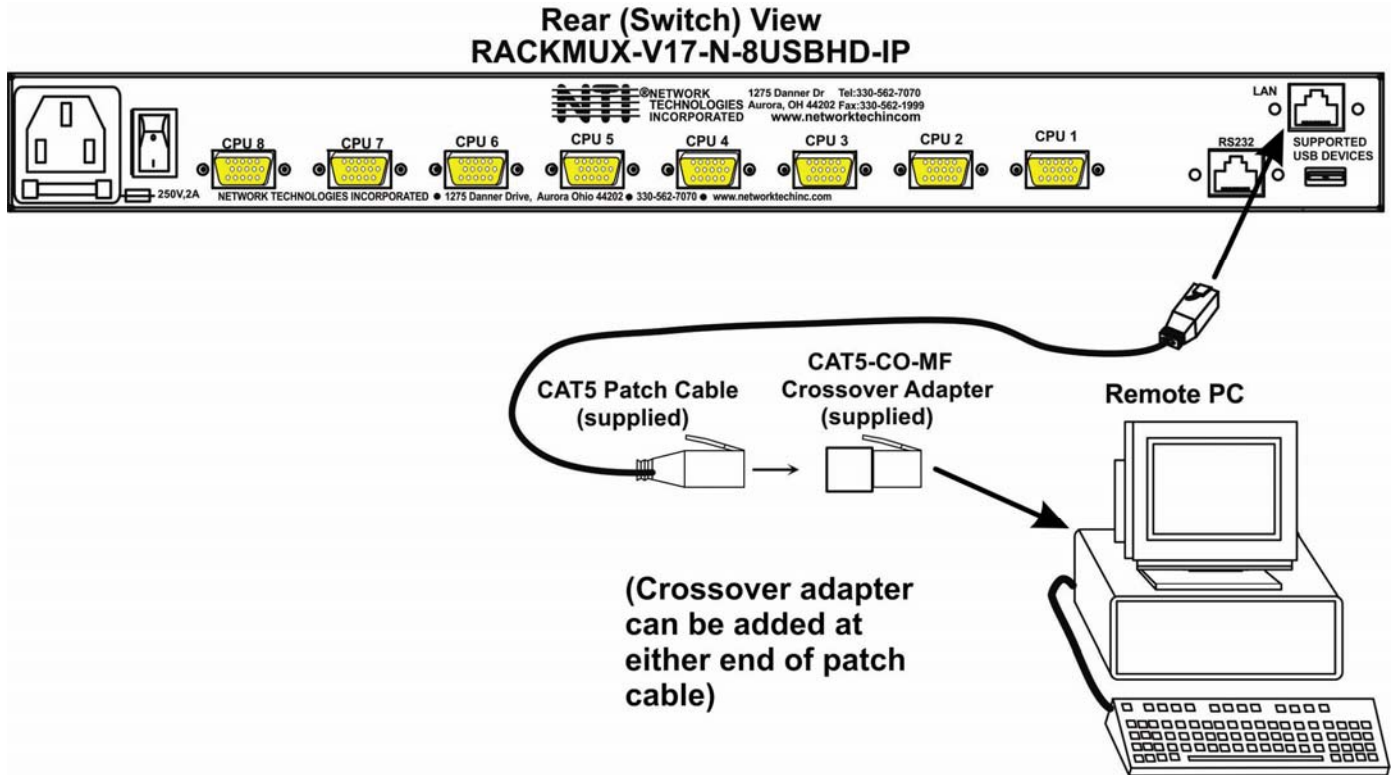

Figure 11- Connect Remote PC to KVM on IP at "LAN" port

2. The default IP of the KVM on IP is 192.168.0.70. The Ethernet port on the PC must be configured with an IP of 192.168.0.xxx where xxx is any number except 70. You may need to configure the Ethernet port network information on the PC such that it can connect to the KVM on IP device in the USB KVM switch

Note: Connecting to the KVM on IP requires the installation of the Java Runtime Environment. A link to the web page from which it can be downloaded and installed in addition to a Windows compatible copy of the application is provided on the Product Manual CD.

3. Open a browser window on the PC. Type "192.168.0.70" into the URL address block. A login prompt will appear.
4. Enter the default user name and password for the KVM on IP:

Username = super
Password = pass



Figure 12- Login Screen for KVM on IP

5. The KVM on IP will open the main menu. If you wish to change the network configuration, go to “**Device Settings**”, and then “**Network**” to open the network configuration settings page for the KVM on IP. If you don’t need to change the network settings, skip directly to step 10.

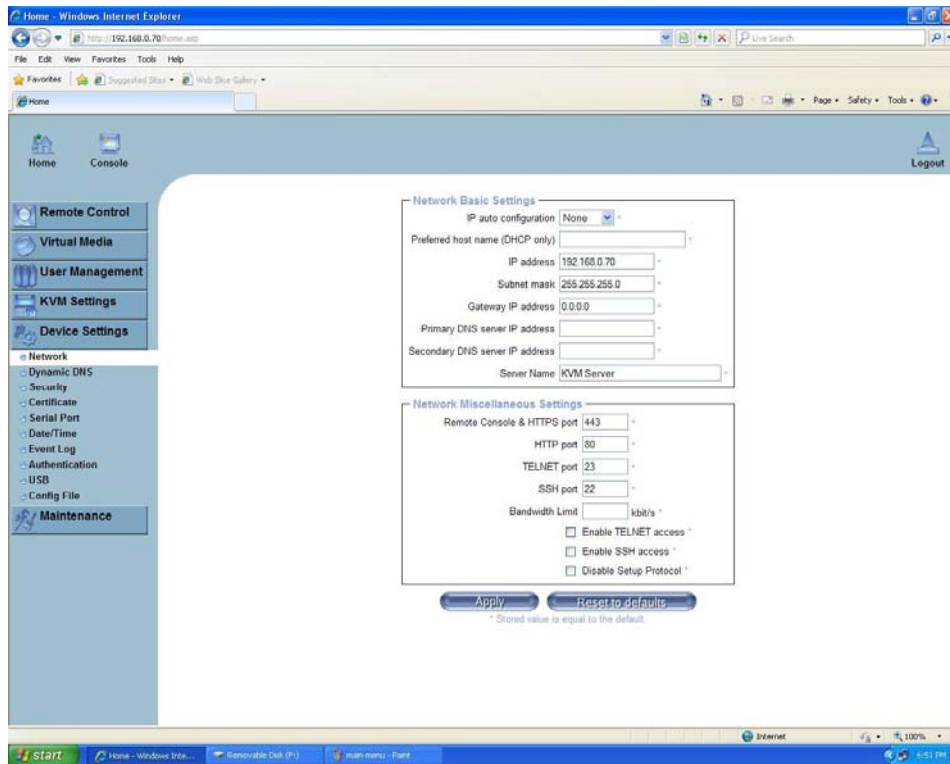

Figure 13- Network Configuration screen

6. Enter the desired network connection settings (IP address, subnet mask, gateway) as compatible with your network.

Make note of these settings in case you need them later.

7. With the settings updated, press “Apply” to implement the changes in the KVM on IP. Your browser connection to the KVM on IP is no longer valid.

8. To restore connection to the KVM on IP, change the IP address on the PC back to an address compatible with your network and now also compatible with the KVM on IP.

Having configured the KVM on IP to be compatible with your network, you can now make a direct cable connection (crossover adapter not needed) to your network through a router or switch.

9. Enter the new IP address in the browser URL address block. Log back into the KVM on IP.

10. With a proper login, a window “**Remote Console Preview**” will be displayed. Click on the link “**Click to open**”.

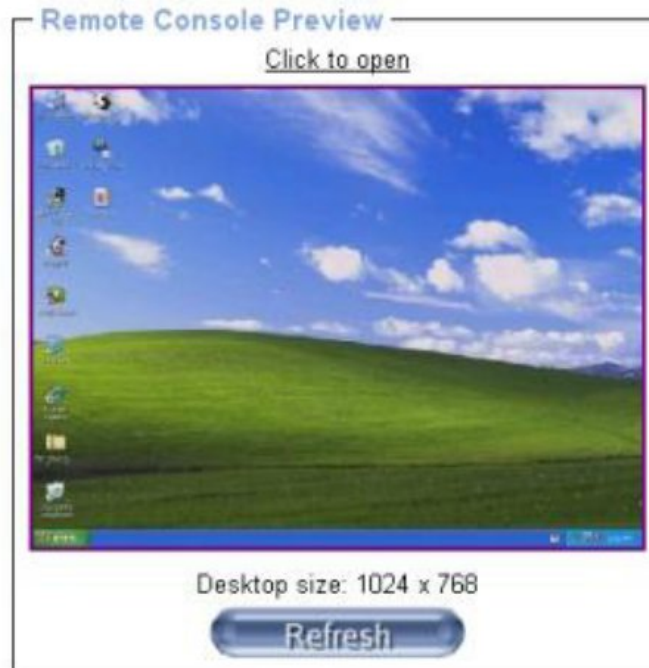

Figure 14- Remote Console Preview

A connection will be made between your remote PC and the RACKMUX Drawer. The screen that opens is a virtual PC that enables you to control the RACKMUX switch just as if you were actually at the keyboard of the RACKMUX. Using the mouse, switch between the virtual PC and your actual computer interface.

Instruction for operating the USB KVM Switch can be found on page 22.

Note: *When using the OSD menu to control the USB KVM switch from the remote PC, use only the keyboard to navigate the menus. The mouse will work as described in the UNIMUX-USBV-xHD manual when used from the RACKMUX-based keyboard, but it is not reliable when used through the KVM on IP connection.*

If the remote connection is closed while in the KVM on IP menu, to re-open the connection click on “**Remote Control**”, then “**KVM Console**”.

Note: *There are more features available in the menu for the KVM on IP, but their use or configuration is not necessary in the operation of the RACKMUX-V17-N-8USBHD-IP.*

FEATURES AND FUNCTIONS

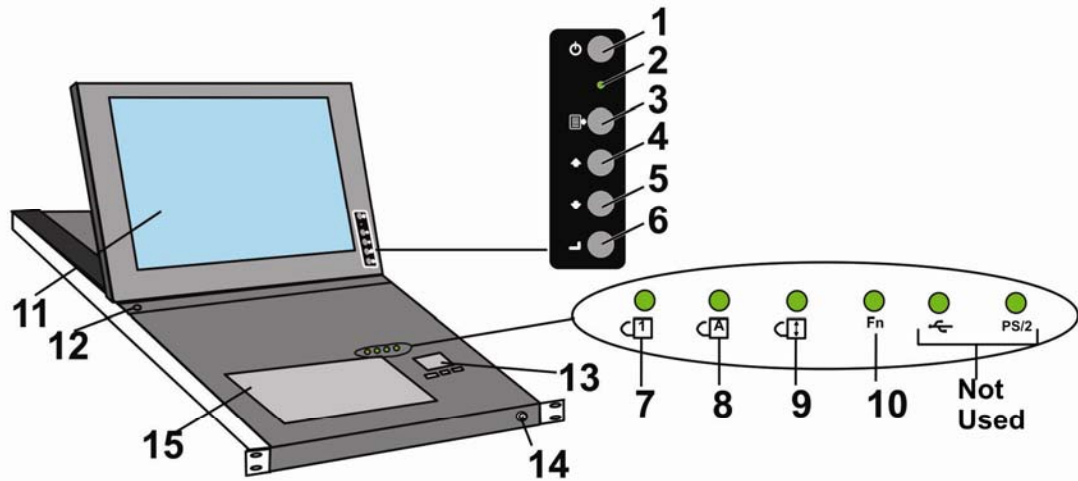

**Front View
RACKMUX-V17-N-8USBHD-IP**

**Rear (Switch) View
RACKMUX-V17-N-8USBHD-IP**

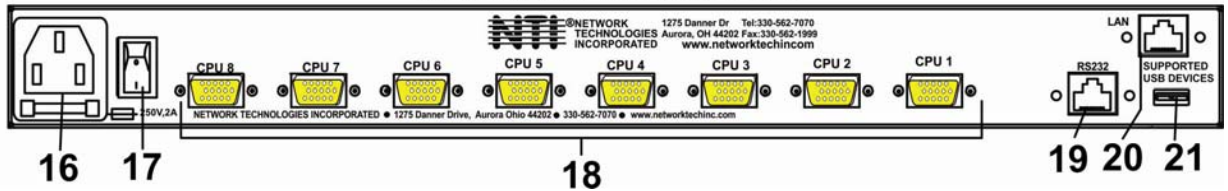

#	LABEL	PHYSICAL	DESCRIPTION
1	Power	Button	press to turn the LCD monitor ON and OFF
2	---	Green/Red LED	Indicates operation status Green = Power-ON, Video Input Signal OK Red = Suspend / Stand-by, or no Video Input Signal
3	Menu	Button	press to turn ON the OSD menu
4	Up Arrow	Button	press to move the cursor in the OSD menu up
5	Down Arrow	Button	press to move the cursor in the OSD menu down
6	Select	Button	press to select a menu item (when OSD menu is ON) or press to auto adjust the video quality (when OSD menu is OFF)
7	NumLock	Green LED	illuminates when the number lock is ON
8	CapsLock	Green LED	illuminates when CapsLock is ON
9	Scroll Lock	Green LED	illuminates when the Scroll Lock keyboard feature is ON.
10	Fn	Green LED	illuminates when Function Features (page 13) are enabled
11	---	LCD Display	for viewing the video signal from the connected CPU
12	---	Auto Shut-OFF	switch automatically shuts OFF the LCD display when the monitor is folded down
13	---	3-button mouse	for controlling mouse movements on the monitor and controlling the computer
14	---	Keylock	to prevent unauthorized use of the RACKMUX
15	---	Keyboard	for manual data entry and computer control
16	---	IEC Connector	for attachment of the IEC power cord to power the RACKMUX drawer
17	---	Switch	for powering ON and OFF the RACKMUX drawer
18	CPU x	15HD yellow female high-density	for connection of CPU cables for video and device support
19	RS232	RJ45 female	for attaching RS232 interface cable from a CPU to control the functions of one or more switches
20	LAN	RJ45 female	(OPTIONAL) for connection to an Ethernet for remote user control via KVM on IP
21	USB Port	USB Type A female	(OPTIONAL) for USB cable of a CAC card reader

More information on the use of the USB KVM Switch features can be found on the manual CD in man039.pdf entitled "UNIMUX-USBV-xHD High Density USB KVM Switch Installation and Operation Manual"

DISPLAY FUNCTIONS

An NTI RACKMUX with a 17" monitor supports resolutions up to SXGA (1280 x 1024), and a 15" monitor supports resolutions up to XGA (1024 x 768), each with a refresh rate at between 55 and 76Hz. The quality of the image on the LCD monitor is adjustable using an On Screen Display (OSD) menu using the control buttons on the RACKMUX.

Standard Controls

The RACKMUX has 5 standard control buttons and a power LED. The 5 standard control buttons operate as follows:

- The **Power** button turns the RACKMUX LCD and backlight ON and OFF as desired.
- The **Power LED** located immediately below the Power button is a dual color LED. It will illuminate with a green color when the RACKMUX is powered ON and working properly. It will illuminate with a red color if the RACKMUX is powered ON but there is no input signal detected.
- The **Menu** button is used to bring up the OSD menu where the various settings of the LCD display can be adjusted. Once the OSD screen is displayed, the Menu button is used to make selections within the menus. See "OSD Control Menu" (below) for more on LCD display settings.
- The **Up and Down Arrow** buttons are used to navigate through the menus. Move the cursor up or down as desired to highlight an item for selection. Once an item is highlighted, pressing the Menu button will select it.

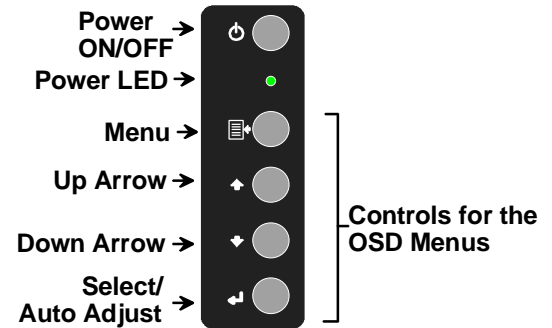

Figure 15- OSD Controls

- The **Select** button is used to make selections within the OSD menus when the OSD menu is ON. When the OSD menu is OFF, the Select button will act as an **Auto Adjust** button to keep the user from having to use the menus to adjust the quality of the image on the monitor.

OSD Control Menu- 15 and 17 Inch VGA models (-V15/-V17)

The OSD (On Screen Display) Menu enables the user to select the desired characteristics of the LCD display. To activate the OSD Menu, press the **Menu** button (above). To turn the Menu back OFF, either select "EXIT" from the main menu or just wait 10-60 seconds and it will automatically be cleared from the screen.

OSD Main Menu



Selection	Purpose	Range
Brightness/Contrast	Increase/decrease panel brightness/contrast level	1-100
Color	R,G,B color temperature control	1-100
Position	<ul style="list-style-type: none"> • Video Image horizontal and vertical position control • Clock setting • Phase control 	1-100
Setup	<ul style="list-style-type: none"> • Control OSD Image position on screen • Set time OSD will stay on screen before auto shutoff • Select the language of the OSD menu 	-- 10 to 60 seconds Several languages (see page 8)
Exit	Exit from the OSD control menu	

Brightness/Contrast Menu

Selecting the Brightness/Contrast menu will bring up a screen in which the user can adjust the brightness and contrast levels of the LCD display. Using the **Up** or **Down Arrows** to navigate the menu, highlight either the BRIGHTNESS or CONTRAST sections and press the **Select** button to choose the option to adjust. Then use the **Up** or **Down Arrow** to adjust the setting. Select EXIT when finished to return to the Main Menu.

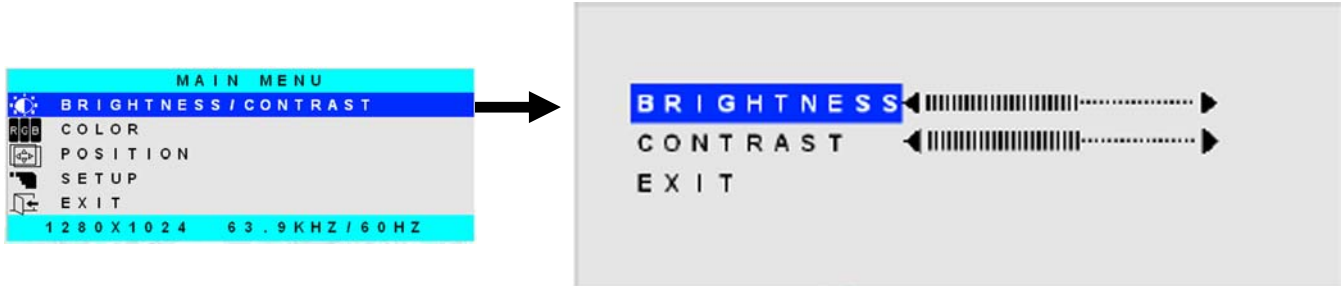

Color Menu

Selecting the Color menu will bring up a screen in which the user can adjust the Red, Green, and Blue color levels (values from 1-100) of the LCD display. With the RED, GREEN, or BLUE sections highlighted, (use the **Up** or **Down Arrow** to move between them), press the **Select** button to choose the option to adjust. Then use the **Up** or **Down Arrow** to adjust the setting. Select EXIT when finished to return to the Main Menu.

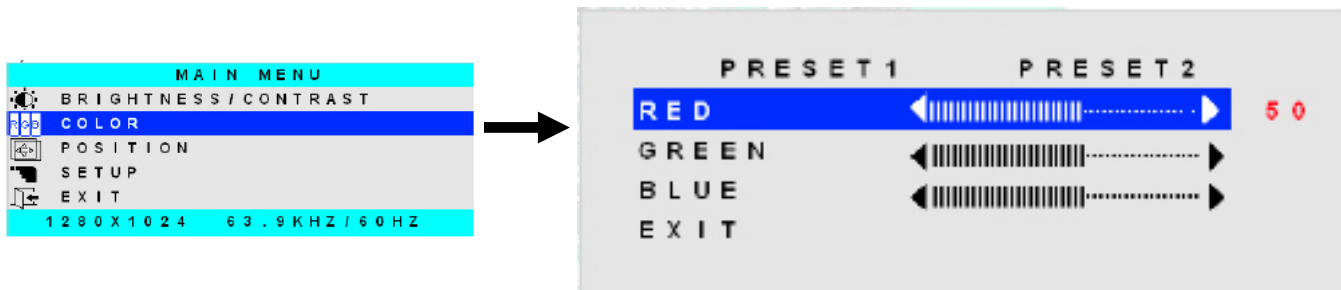

Position Menu

Selecting the Position menu will bring up a screen in which the user can select AUTO ADJUST to automatically adjust the horizontal and vertical position of the displayed image on the monitor, as well as adjust the clock and phase settings if they are not correct. The user can also individually adjust these settings if so desired. With any of the sections highlighted, (use the **Up** or **Down Arrow** to move between them), press the **Select** button to choose the option to adjust. Then use the **Up** or **Down Arrow** to adjust the setting as needed. Select EXIT when finished to return to the Main Menu.

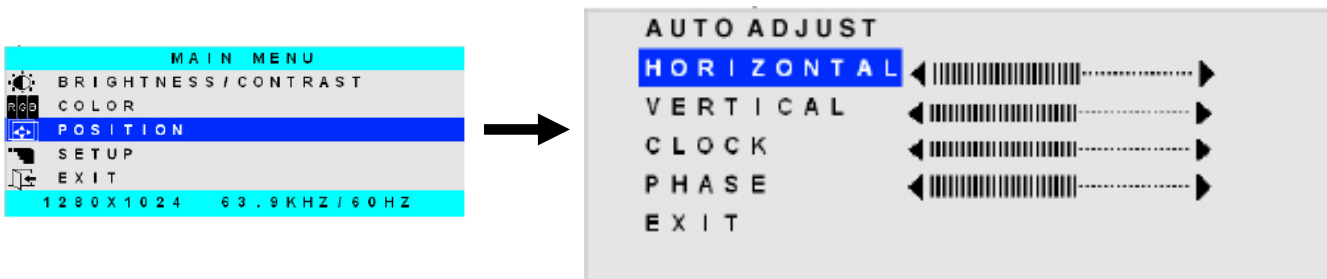

Setup Menu

Selecting the Setup menu will bring up a screen in which the user can adjust

- OSD POSITION-the position of the OSD menus on the LCD display
- OSD TIME-the length of time the user can be idle before the OSD menu automatically exits (adjustable from 10 to 60 seconds)
- LANGUAGE-the language that the OSD menus will be presented in

With the item highlighted, (use the Up or Down arrow to move between them), press the Select button to choose the option to adjust. Then use the Up or Down Arrow to adjust the setting as needed. Select EXIT when finished to return to the Main Menu.

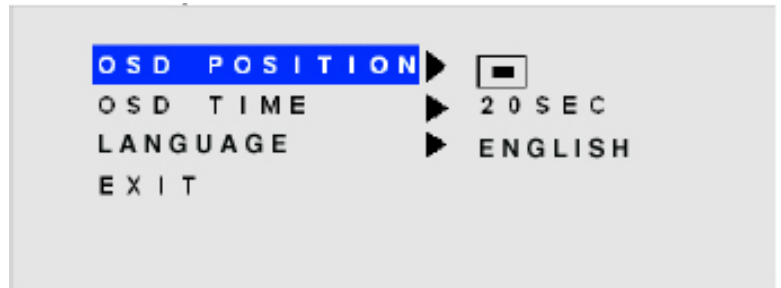
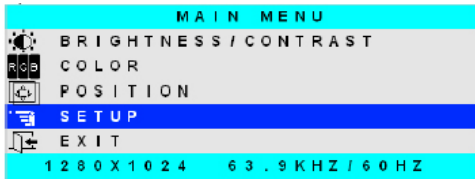

OSD Image can be moved to different points on the display

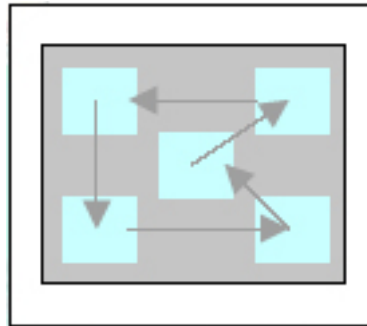

OSD Control Menu-DVI Model (-D17)

The OSD (On Screen Display) Menu enables the user to select the desired characteristics of the LCD display. To activate the OSD Menu, press the **Menu** button (page 13). To turn the Menu back OFF, either select "EXIT" from the main menu or just wait 10-60 seconds and it will automatically be cleared from the screen. Any changes made before exiting the menu will be saved.

OSD Main Menu



Note: In order to display the OSD Menu, the RACKMUX must first be connected to a video source (see "Connect to a CPU" – page Error! Bookmark not defined.).

Note: If menu does not appear when the Menu button is pressed, the monitor may be set for a "PC" (VGA) input source. Press the Up Arrow button on the monitor to switch it to a "Digital" (DVI) input source.

Selection	Purpose	Range
Brightness/Contrast	Increase/decrease panel brightness/contrast level	1-100
Setup	<ul style="list-style-type: none"> Control OSD Image position on screen Set time OSD will stay on screen before auto shutoff Select the language of the OSD menu Select Input Source to display 	<ul style="list-style-type: none"> 0-4 10 to 60 seconds English, Spanish, German, Italian, or French Digital or PC (<u>must</u> be set to Digital)
Exit	Exit from the OSD control menu	

Brightness/Contrast Menu

Selecting the Brightness/Contrast menu will bring up a screen in which the user can adjust the brightness and contrast levels of the LCD display. Using the Up or Down arrows to navigate the menu, highlight either the BRIGHTNESS or CONTRAST sections and press the **Select** button to choose the option to adjust. Then use the Up or Down Arrow to adjust the setting. Select EXIT when finished to return to the Main Menu.

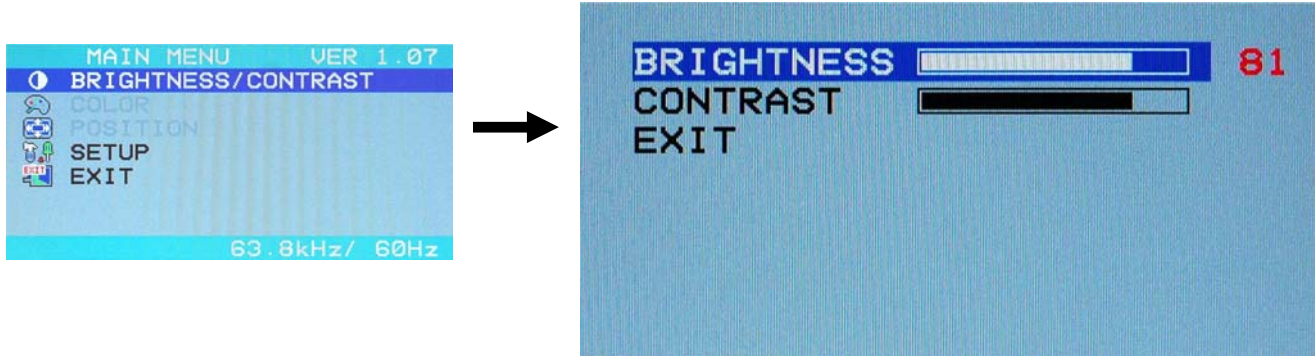

Setup Menu

Selecting the Setup menu will bring up a screen in which the user can adjust

- OSD POSITION-the position of the OSD menus on the LCD display (positions 0-4)
- OSD TIME-the length of time the user can be idle before the OSD menu automatically exits (adjustable from 10 to 60 seconds)
- LANGUAGE-the language that the OSD menus will be presented in
- INPUT SOURCE- the type of signal that is coming from the CPU, either Digital (DVI) or PC (VGA)

NOTE: As used on this RACKMUX, the INPUT SOURCE must be set to "Digital".

With the item highlighted, (use the **Up** or **Down Arrow** to move between them), press the **Select** button to choose the option to adjust. Then use the **Up** or **Down Arrow** to adjust the setting as needed. Select EXIT when finished to return to the Main Menu.

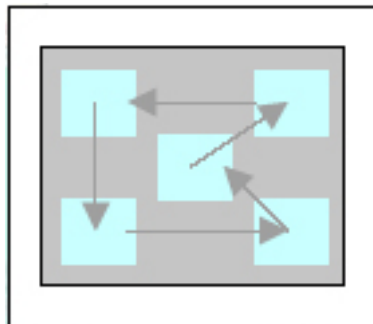
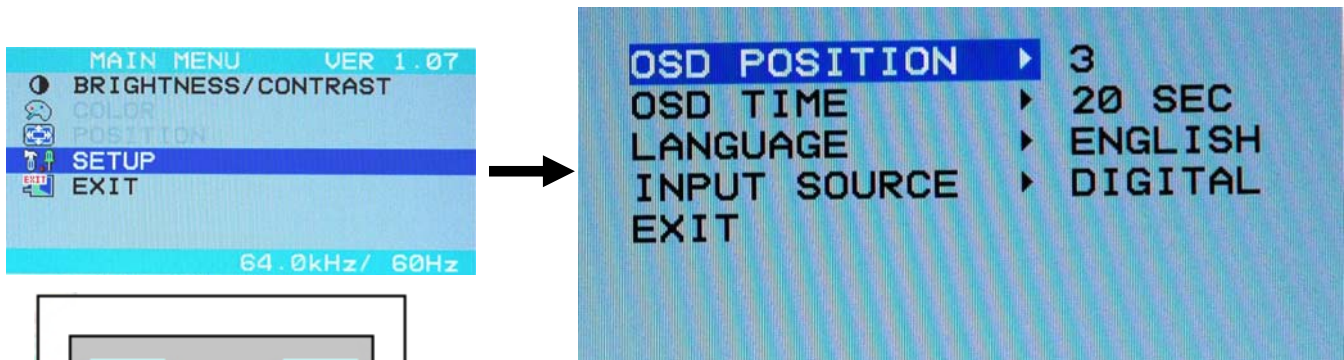

OSD Image can be moved to different points on the display

OSD Control Menu- 17 Inch Hi-Resolution Model (-HR)

The OSD (On Screen Display) Menu enables the user to select the desired characteristics of the LCD display. To activate the OSD Menu, press the **Menu** button (below). To turn the Menu back OFF, either press the Exit button or just wait approximately 10 seconds (timing is adjustable) and it will automatically be cleared from the screen. Any changes made before exiting the menu will be saved.

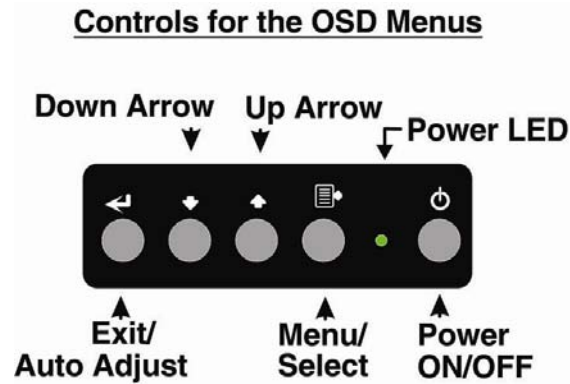

OSD Main Menu

The Main Menu is broken into five sections, Color, Picture, Function, OSD Menu, and Misc. Press one of the arrow buttons to move between them. The Picture and Function sections only apply when the RACKMUX is connected as VGA instead of DVI. To select a menu and move to characteristics within them (i.e. CSM, Brightness, or Contrast under the Picture menu), press the **Select** button while the desired menu is displayed.

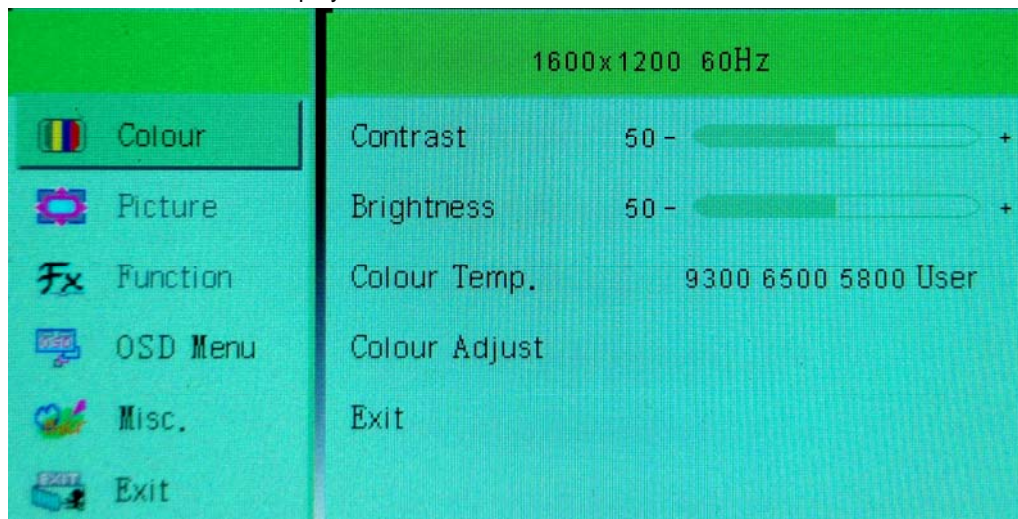

Characteristics that can be adjusted are described in the chart below.

Selection	Purpose	Range
Colour Contrast Brightness Colour Temp. Colour Adjust	<ul style="list-style-type: none"> Increase/decrease panel contrast level Increase/decrease panel brightness level Set panel color temperature Select RGB balance (goes to submenu) 	<ul style="list-style-type: none"> 0-100 0-100 5800K,9300K,6500K,User 0-100
Picture (VGA Only) H Position V Position Phase Clock Sharpness	<ul style="list-style-type: none"> Control Horizontal position of screen Control Vertical position of screen 	<ul style="list-style-type: none"> 0-100 0-100 0-100 0-100 1-5
Function (Fx) (VGA Only)	To manually force auto adjust of monitor settings	Select Auto Adjust or Auto Color functions

OSD Menu Language OSD H. Pos. OSD V. Pos. OSD Timer Translucent	<ul style="list-style-type: none"> Select the language of the OSD menu Control Horizontal OSD Image position on screen Control Vertical OSD Image position on screen Control if OSD will time out Adjusts how boldly the menu is displayed 	<ul style="list-style-type: none"> English, Spanish, German, Italian, or French 0-100 0-100 On/Off If On, select 3-100 seconds. -/+
Misc.	<ul style="list-style-type: none"> Select Input Reset monitor to default settings 	<ul style="list-style-type: none"> VGA or DVI Yes/No

Press the **Exit** button or select "Exit" to exit the OSD menu.

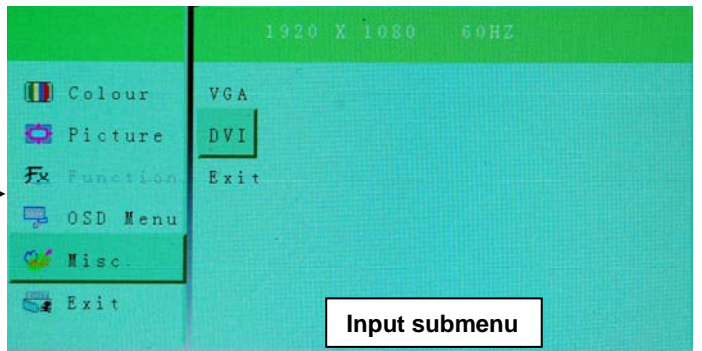
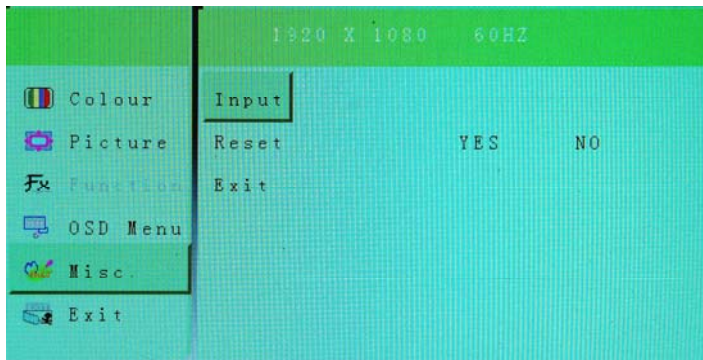
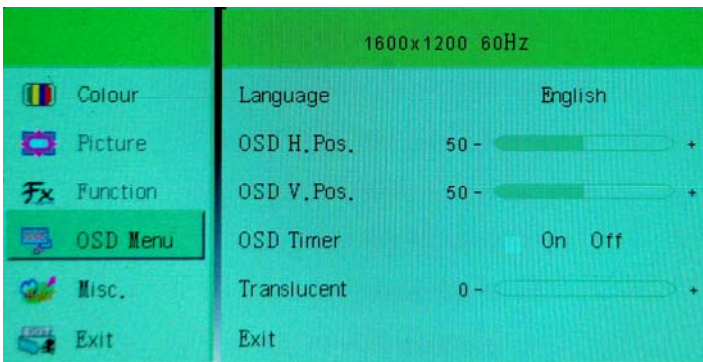
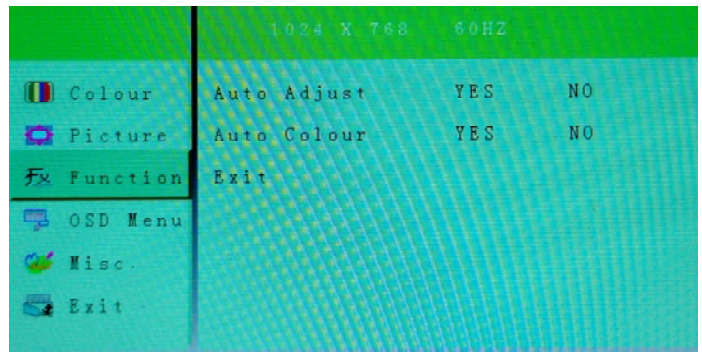
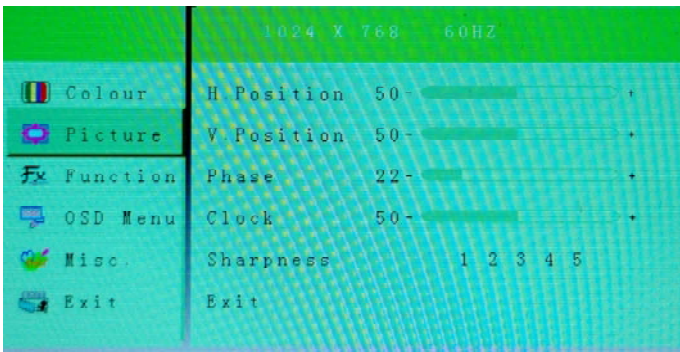
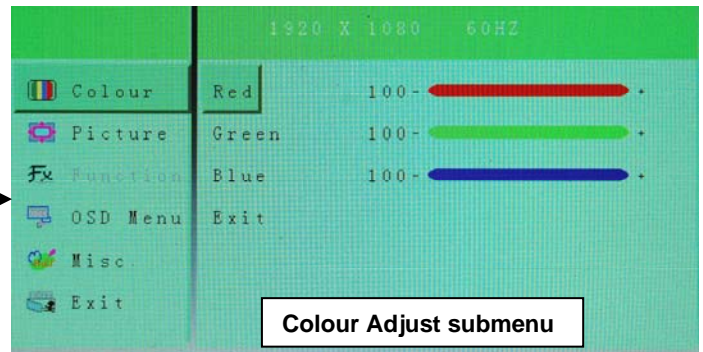
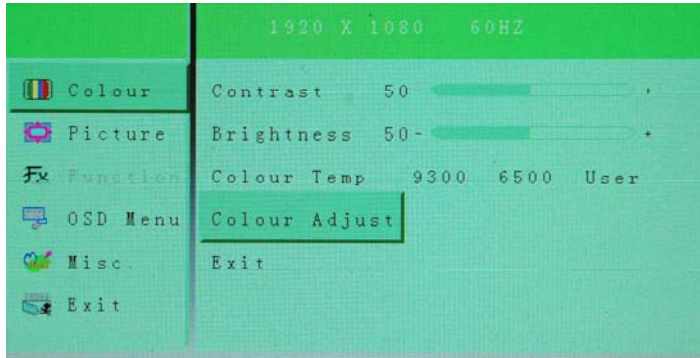

KEYBOARD FUNCTIONS

The keyboard on the RACKMUX-Vxx is a standard condensed Windows format. To reduce the keyboard size, some keys have been assigned multiple functions, accessible via the "Fn" key. This section will describe which keys have multiple functions and how to enable them. Use the LEDs to know what special features are enabled.

Function Key Operation

The Function ("Fn") key provides several special functions on the RACKMUX keyboard, including:

- enabling otherwise standard keyboard keys to be used as the keys of a numeric keypad
- enabling multi-function keys to change operation
- enabling the "T" key to act as a mode key to toggle between USB and PS/2 keyboard/mouse mode

To turn ON (lock) the Function key, press the "Fn" key twice quickly (double-click). The "Fn" LED will illuminate.

To turn OFF (unlock) the Function key, press the "Fn" key twice quickly again. The "Fn" LED will turn OFF.

Note: The "Fn" key will also operate similar to the shift key (with only momentary effect). Press and hold the "Fn" key prior to pressing the special function key. The "Fn" key will remain active as long as it is depressed.

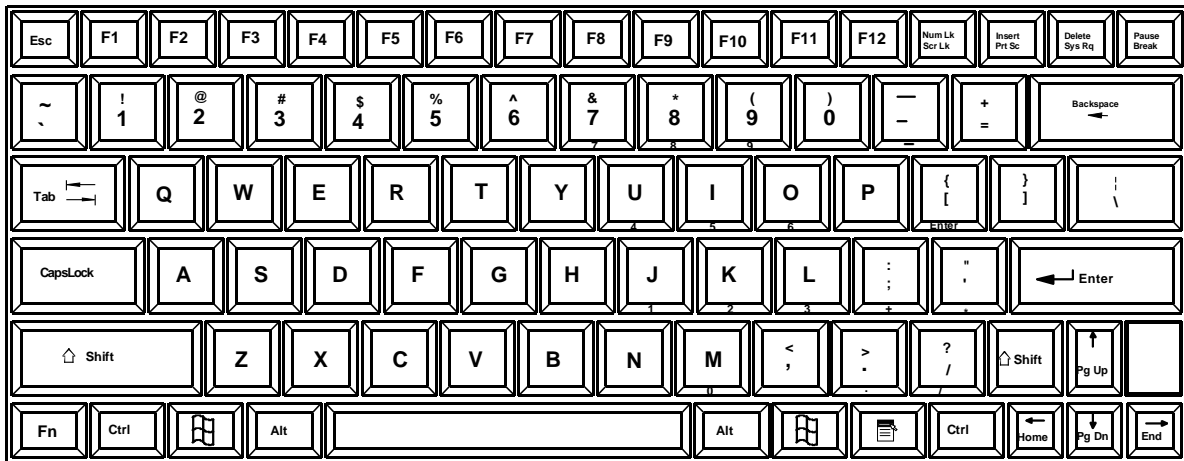

Function Key to enable additional key functions

Figure 16- US(English) Keyboard Layout

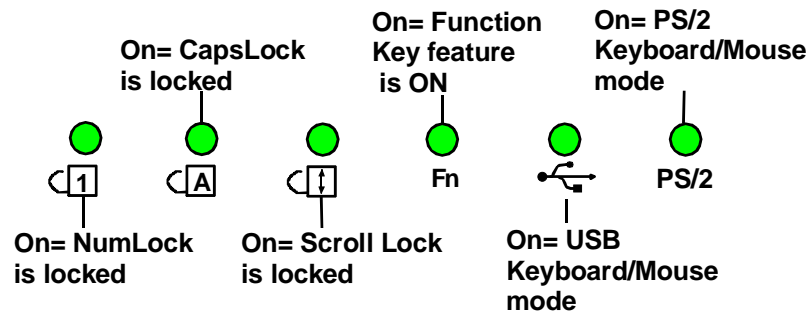

Figure 17- Keyboard LED Indications

Numeric Keypad Option

This RACKMUX has a standard Windows keyboard with 17-key numeric keypad.

The Function (“Fn”) key, (page 19) is only used to toggle between PS/2 and USB keyboard/mouse mode (page 21). When using the RACKMUX-V17-N-8USBHD-IP, the RACKMUX should always be left in USB mode.

Note: When the Numeric Keypad is present, the “Fn” key does not lock. Instead, the “Fn” key operates similar to the shift key (with only momentary effect).

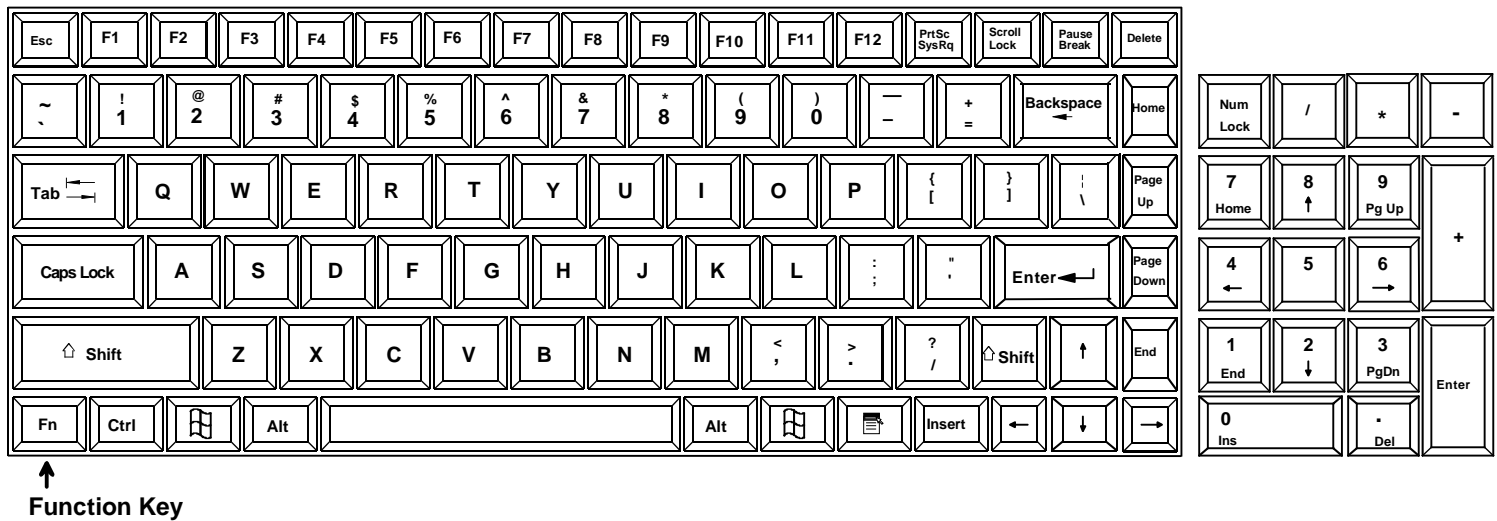

Figure 18- U.S. (English) keyboard with numeric keypad

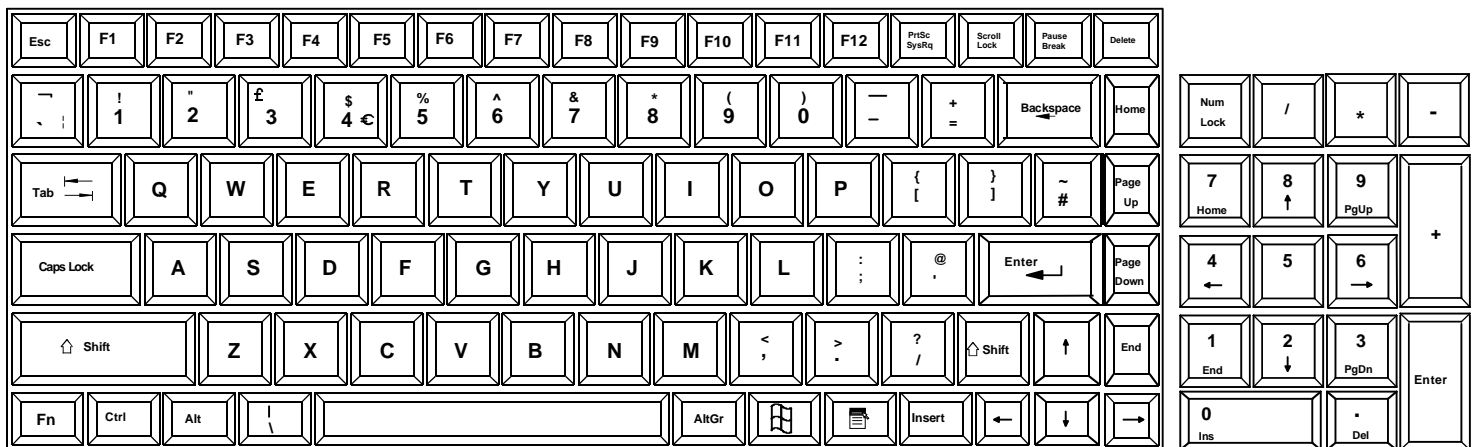

Figure 19- U.K. (English) keyboard with numeric keypad

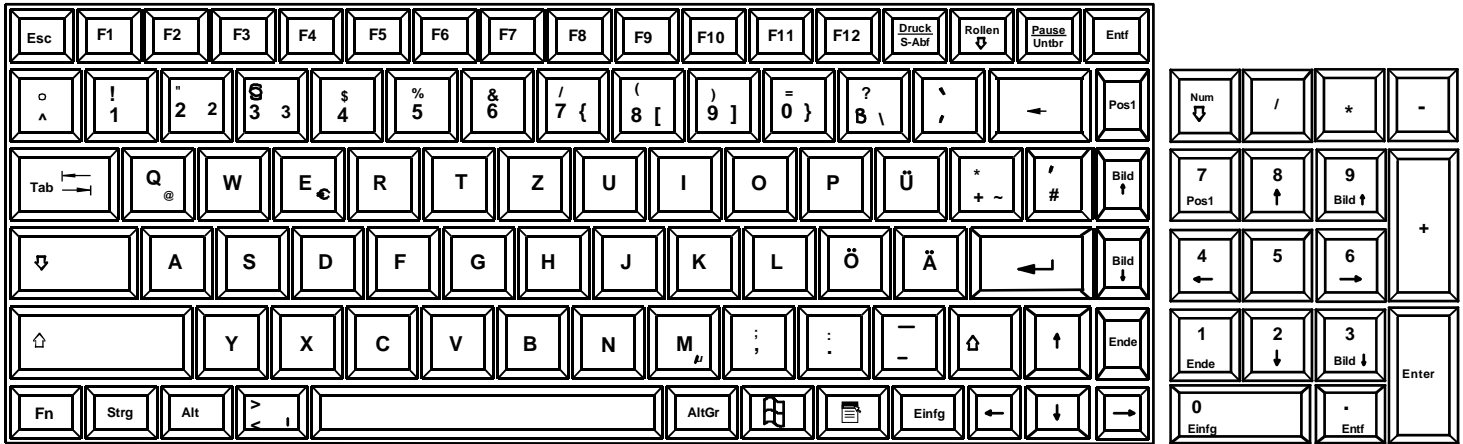

Figure 20- German keyboard with numeric keypad

PS/2-USB Keyboard/Mouse Mode

The RACKMUX keyboard and mouse can be configured to connect to either a PS/2 or USB enabled CPU. At initial power ON from the factory, the keyboard will be in USB mode.

Note: There is no reason to toggle this model RACKMUX to PS/2 mode but this instruction is provided in the event USB mode is inadvertently changed to PS/2 mode. If this happens, the keyboard and mouse will lose their ability to function. Toggle back to USB mode to restore functionality.

1. To toggle the keyboard to USB mode, depress and hold the “Fn” key (“Fn” LED will illuminate) and the “T” key for at least 7 seconds. Release both keys.
2. To toggle the keyboard back to PS/2 mode, press and hold the “Fn” and “T” keys again for at least 7 seconds. Release both keys.

Note: In the event of a power failure, the RACKMUX will power up the keyboard in the mode it was last configured for.

USING THE UNIMUX USB KVM SWITCH

Basic Operation

Once the UNIMUX is properly connected, the UNIMUX will enable a connection to be made between the CPUs attached to its CPU ports and the RACKMUX keyboard, monitor and mouse.

The UNIMUX can be controlled by two methods:

- OSD Control via keyboard using the RACKMUX
- RS232 control (see page 43)

OSD Control

OSD control of the UNIMUX can be achieved using OSD Command Mode. Command Mode is operated using the keyboard and mouse in conjunction with OSD menus superimposed onto the monitor.

By pressing <Ctrl> + <`> (accent key), the user can enter Command Mode. Once in Command Mode, typing a series of commands will cause the UNIMUX to connect the user to any one CPU connected to the switch. Pressing the <Esc> key will exit Command Mode.

OSD CONTROL

OSD superimposes a menu system on the user's video screen with a list of all connected CPUs. OSD allows CPUs to be named (with up to 12 character names). OSD then allows selection of CPUs by that name. Connected CPUs can be listed by name or by port number. OSD Search Mode enables the user to type in the first few characters of the CPU's name and the OSD will locate it. HELP screens assist with all OSD functions.

Guidelines for Navigating OSD Menus

Throughout this manual, various rules apply to navigating the menus used to control and operate the UNIMUX.

- *OSD menus can be navigated using the mouse, the arrows on the keyboard, hot keys (highlighted in red) and the <Page Up>, <Page Down>, <Home>, <Tab> and <End> keys.*
 - *The <up arrow> and <down arrow> moves the cursor up or down one line item at a time in a scrollable window, or between menu items in a menu item list*
 - *The <left arrow> and <right arrow> will move the cursor left or right through menu items or while in editable fields (such as when editing port names)*
 - *<Page Up> and <Page Down> increase/decrease the listed ports by one page at a time*
 - *<Home> will jump to the beginning of the list*
 - *<Tab> will jump between selectable fields, left to right to move between menu items*
 - *<Shift>+<Tab> will jump between selectable fields, right to left*
 - *<End> will jump to the end of the list.*
- *Only alphabetic and numeric characters can be typed in the OSD menu fields*
- *Positioning the mouse cursor over a menu function or CPU name will highlight the background (green highlight for menu functions, cyan or light blue for CPUs)*
- *The scroll bar can be used by clicking on the corresponding up and down arrow above and below the scroll bar.*
- *The mouse wheel may be used to move the selection bar*
- *The <Shift> key must be used to enter an uppercase letter within all OSD menus.*
- *Clicking on a listed CPU while in Command Mode will connect the user to that CPU.*
- *Available functions will have white characters with one red character. The red character corresponds to a keyboard "hot key". Hot keys are not case sensitive. Functions that are not available will be transparent.*
- *When changing characters for names, passwords, or values within an edit field, click on the field or select and press <Enter> to enter the field for editing, and press <Enter> again to exit the edit field.*
- *To exit (and step back 1 menu) from any menu, press <Esc> on the keyboard .*
- *All screens that include "F1:Help" for context-sensitive help will also respond to pressing the <F2> key to provide "Global Help" screens with basic menu navigation help.*

Security Option

The security option in the OSD Control of the UNIMUX USB KVM switch enables an administrator to control access to CPU ports for each user. Up to 63 users can be created. These users have controlled access to any CPU. Only the administrator can activate or deactivate the security features on the user port. Finally, the administrator can set a maximum idle time value after which the current user will be logged out and the login screen displayed again if the user has no activity. The current security status, idle time out, and scan dwell time are all saved and will be restored whenever power to the switch is cycled OFF, then ON. To reset the administrator's password call NTI and have the device serial number of the UNIMUX available. For more on security, see page 30.

Initial startup

When the UNIMUX is first powered ON, a splash screen similar to the following will appear:



Press any key and the UNIMUX will connect you to the first CPU port with a connected CPU that is powered ON. To access Command Mode and connect to a different port or perform other user access functions (see below), press <Ctrl> + <~> (accent/tilde key).

User Access Functions

Command Mode

In order to control the switch with the keyboard, Command Mode must be enabled. To enable Command Mode from the keyboard:

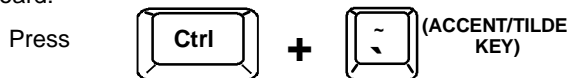

All the status lights on the keyboard will illuminate to indicate that Command Mode is enabled. At this point, the Command Mode menu will be displayed.

The Command Mode menu (see Figure 21) lists all CPUs by name and port number. Only 8 ports are listed on the screen at a time. To view the other portions of the list, scroll using the arrow keys on the keyboard or use the mouse to click on the arrows on the scroll bar in the OSD menu. When the Command Mode main menu is displayed, the first displayed port in the list will be the port the current user is connected to, followed by the next seven consecutively numbered ports. (Alternatively the list may be sorted alphabetically- press the letter <O> to toggle sort method.) The names of accessible ports are displayed with blue characters. If Security is activated, the access rights for the user logged-in may not include all ports. Names of restricted access ports are displayed in black.

An arrow to the left of a port number in the list indicates the port the user is currently connected to. From left to right, the columns display the following:

- Port Number
- Port Name
- Power Status of the CPU (ON/OFF)

Note: "NAC" indicates a non-accessible computer for that user

- The actual user number (1-8) connected to the CPU.
 - If no user is connected to a CPU, the user number is replaced by a "-" (dash).

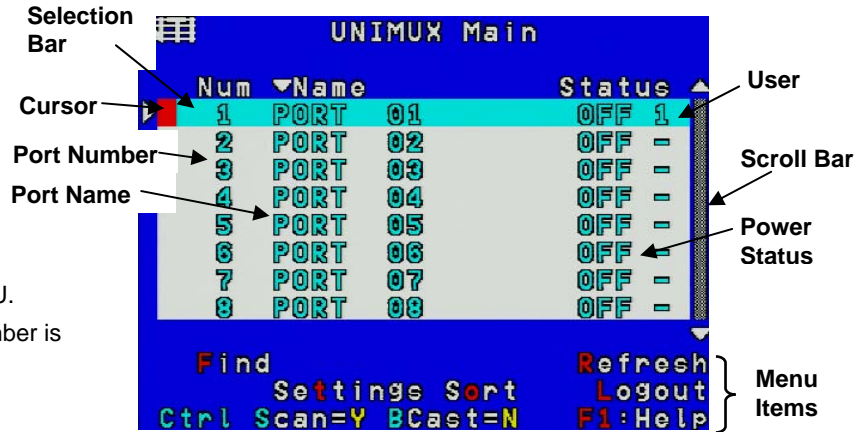

Figure 21- Command Mode main menu-User

Note: While in Command Mode, the numbers on the NUM PAD on the keyboard are not active. If numbers are required while in Command Mode, use the numbers on the main key bank.

The list below describes the command functions available from the keyboard within the OSD mode of control after entering into Command Mode:

Function	Keystroke
Select the previous port	up arrow
Select the next port	down arrow
Go to specific port- Press any valid number from 1-1024 to connect to a desired port.	port # - Enter
Increases the ports listed by 1 page	Page Down
Decreases the ports listed by 1 page	Page Up
Enter "Settings" menu	T
Toggle ports listed to view by port number or alphabetically by port name	O (letter, not number)
Enable/disable Scan Mode	Ctrl + S
Enable/disable Broadcast Mode	Ctrl + B
Enter Administrator menu (only available if the Administrator is logged in)	A
Select the first port on the switch	Home
Select the last port on the switch	End
Display Help menu	F1
Global Help- display window navigation tips used throughout all menus	F2
Display port information- when pressed, a window displays the port name and its position in the configuration structure by level and port number	F3
Update configuration- use to update the information describing the structure of the cascaded switches. Use if a slave is powered-ON or OFF at any time after initial startup	R or F5

Note: The user must exit Command Mode to type to a CPU.

To exit Command Mode press <Esc> on the keyboard.

Function	Keystroke
Enter Find Mode, add a character to search string and select the CPU's name that matches best. Type any alphabetical or numeric character (A-Z, 0-9) <i>Note: use is not case sensitive</i>	F
Switch to selected port	Enter
Logout (you will be prompted for confirmation)	L
Exit Command Mode	Esc

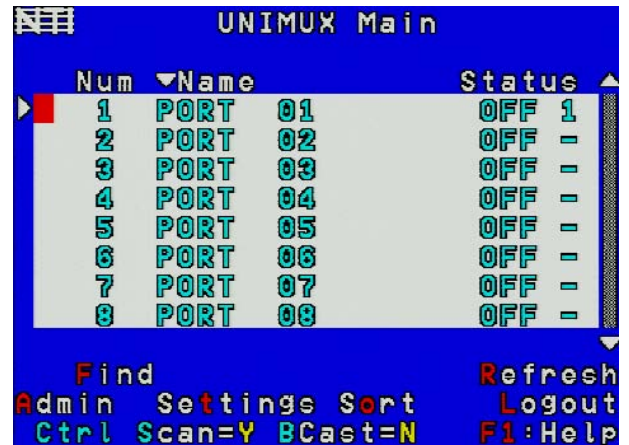

Figure 22- Administrator's main menu

Settings

To enter the Settings menu (see Figure 23) press <T> from the Command Mode menu. The list below describes the Settings menu functions available from the keyboard:

Function	Keystroke
Open OSD Settings screen	O
Go to Broadcast list	B
Go to Scan list	S
Change the scan dwell time period Enter any value from 002-255 (for more on this-see "Scan Mode" page 28)	T
Enable/Disable right mouse button click emulation with Apple 1-button mouse (see "Mouse Click Equivalents" on page 41 for more)	R
Exit from Settings menu Return to Main menu	Esc



Figure 23- Settings menu

When the <T> is pressed, the current value of the scan dwell time is selected with an edit field (see Figure 23) . The user can introduce a new value for scan dwell time and press <Enter> to save it or <Esc> to exit. Any value between 002 and 255 (seconds) is acceptable.

OSD Settings

The OSD Settings screen enables the user to adjust the height of the OSD screen on the monitor and the position of it. The position can be adjusted both horizontally, as well as vertically. Press <O> from the Settings menu (page 26) to open the OSD Settings screen.

Function	Keystroke
Make OSD window taller	T
Make OSD window shorter	S
Move OSD window vertically	up or down arrow
Move OSD window horizontally	left or right arrow
Exit and save OSD Settings	Esc



Figure 24- OSD Settings screen

Find Mode

Find Mode is enabled by typing any alphabetical or numeric characters while in the Command Mode main menu, or by pressing <F> while in supporting menus.

Find Mode allows the user to enter and maneuver through a list of CPU names. The CPU name best matching the characters typed is selected. The list of CPUs may also be searched for a specific (or similar) name. The Find Mode function is not case sensitive. The following commands are valid when the search option has been invoked from Command Mode.

Function	Keystroke
Erase previous character in search name	Backspace
Add a character to the search string and select the best matching CPU name	A-Z, 0-9 (upper or lower case)
Exit Find Mode	Esc or Enter

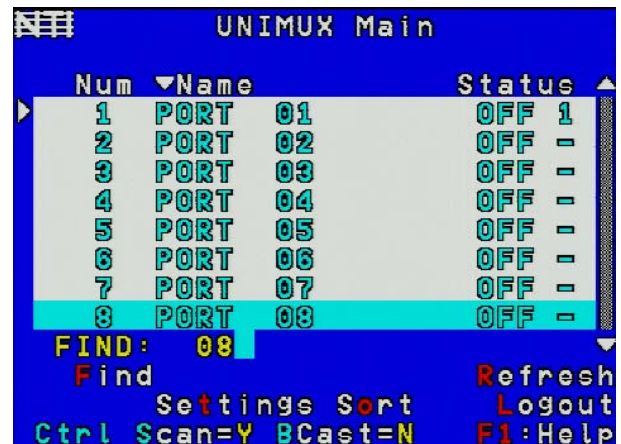

Figure 25- Find Mode in use

Help Mode

To enter Help Mode press the <F1> key from the Command Mode menu (see page 13).

Help Mode displays a list of commands with a short explanation of their function. The following options allow the user to quickly obtain information on any command.

Function	Keystroke
View the previous page of help if available	Page Up
View the next page of help if available	Page Down
Exit Help Mode	Esc



Figure 26- Main Menu help screen

Scan Mode

Using Scan Mode, the user can automatically switch from one CPU to another in predetermined configurable time intervals. The CPU ports to be scanned are easily selected provided the user has access to them. At initial startup, the user has access to all CPU ports by default.

To activate or deactivate Scan Mode press <Ctrl> + <s> from the Command Mode menu. The text shown in the menu (see Figure 22) will toggle between "Scan=N" and "Scan=Y", each time the <Ctrl> + <s> keys are pressed. When "Scan=Y" is shown, Scan Mode is active. When "Scan=N" is shown, Scan Mode is OFF.

From the Settings menu (see page 26) press <s> to access the "Scan List". The Scan List enables the user to select specific ports to be active in Scan Mode. While active, the user will have full device control of the connected port. Only the selected ports will be scanned in Scan Mode.

The "Scan List" is a check list with all the port numbers displayed

- unchecked box = the corresponding port is **not** in the scan list
- checked box = the corresponding port **is** in the scan list

From the "Scan List" the user can:

- toggle the state of the selected port (press <Spacebar>)
- select all ports to be scanned (press <A>)
- deselect all ports so that none are scanned (press <N>)
- find a specific port to either select or deselect (press <F> , then any alphabetical or numeric character to locate the desired port).



Figure 27- Scan List

A port is skipped from the scan cycle if one of the following conditions is true:

- the port is not in the Scan List
- Security Mode is enabled and the user does not have access rights to the port
- the CPU connected to the port is OFF

When switching to a new port the port name is displayed by OSD in the left upper corner of the monitor for 5 seconds or until a key is pressed or the mouse is moved, whichever comes first. The **scan dwell time** is programmable from 2 to 255 seconds (default time-out period is 5 seconds). While using the mouse, keyboard or touchscreen the scanned port becomes active and scanning is stopped. The switch will resume scanning after a period of user inactivity determined by the scan dwell time. See Settings Menu on page 26 for configuring the scan dwell time.

To return to the Settings menu, press <Esc>. The scan selection list is automatically saved.

Note: The scan dwell time set by the user affects all users.

Note: The keyboard, mouse and touchscreen must remain idle for the full scan dwell time before the switch selects the next active port.

Broadcast Mode

To activate or deactivate Broadcast Mode press <Ctrl> + from the Command Mode menu. The text shown in the menu (Figure 22) will toggle between “BCast=N” and “BCast=Y”, each time the <Ctrl> + keys are pressed. When “BCast=Y” is shown, Broadcast Mode is active. When “BCast=N” is shown, Broadcast Mode is OFF.

Broadcast Mode enables the user to type characters to more computers simultaneously. From the Settings menu (see page 26) press to access the “Broadcast List” where the user can edit the list of ports that receive data in Broadcast Mode.

The “Broadcast List” is a check list with all the port numbers displayed

- unchecked box = the corresponding port is **not** in the broadcast list
- checked box = the corresponding port **is** in the broadcast list

From the “Broadcast List” the user can:

- select all ports to be broadcasted to (press <A>)
- deselect all ports so that none are broadcasted to (press <N>)
- select only a limited number of ports to be broadcasted to
- find a specific port to either select or deselect (press <F> , then any alphabetical or numeric character to locate the desired port).



Figure 28- Broadcast List

A port doesn't receive broadcast data if one of the following conditions is true:

- the port is not in the Broadcast List
- Security Mode is enabled and the user does not have access rights to the port

Note: The user must type somewhat slowly when in Broadcast Mode (less than 20 wpm) and cannot use the <Backspace> key.

Note: The mouse and touchscreen will be disabled while in Broadcast Mode.

To return to the Settings menu, press <Esc>. The broadcast selection list is automatically saved.

Normal Mode

When the UNIMUX switch is not in Command, Scan, or Broadcast mode and the OSD control is not active on the monitor, the user is in Normal Mode, controlling the CPU to which the user is connected through the UNIMUX switch.

Security

Enabling Security

To enable the security feature the administrator must first enter Command Mode. If the Command Mode menu is not already displayed, press <Ctrl> + <~> (accent/tilde key). The OSD menu will automatically appear on the monitor.

To login as the administrator, the user must first logout by pressing <O>, and then <Y> to confirm. A login prompt will appear.

Password and User Name

The factory settings are:

- default user name = <root>
- default password = <nti>

Note: The username for the administrator cannot be changed from "root".



Figure 29- User login screen

Note: The <F1> Autologin key (see Figure 31) is only for use by users other than the administrator, and is only displayed and available for use if security is not enabled.

With a valid login, the user will be connected to the first CPU that is powered-ON. To enter Command Mode, press <Ctrl> + <~> (accent/tilde key). The OSD menu will automatically appear on the monitor.

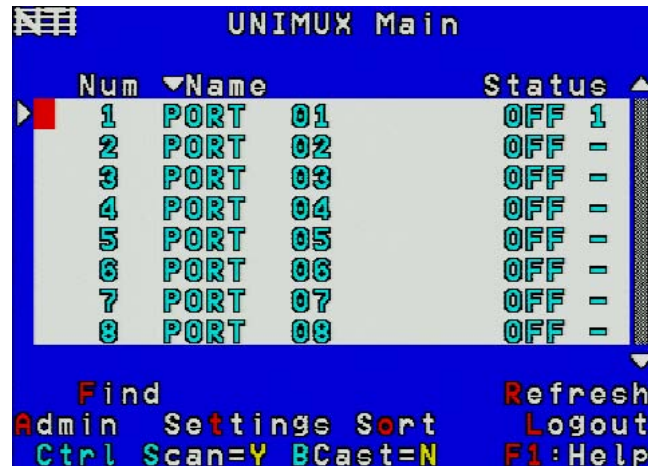

Figure 30- Administrator's main menu

The administrator will activate security (after logging in) by pressing <A>-<S>-<S>-<E> (see page 38).

Once logged-in, follow the instructions on page 31 for setting up users and changing the password. Once the password is setup, if it is lost or forgotten the administrator will have to contact NTI for assistance on clearing the password and set it up again. The administrator can setup each of the users and the limitations of their use of the individual CPUs using the administration menus.

When a standard user powers up the UNIMUX with security enabled, the login screen will appear. Enter the user name and password as set by the administrator. Unless a valid user name and password are entered, the login screen will remain on the monitor. For more on "User Login", see page 31.

User Login

User Login Mode requires a user to login with a user name and password from the list created by the administrator. The user will only be able to login if security is enabled. With security enabled, the user will be locked to the current CPU and the login screen will remain on the monitor until the user logs in.

Function	Keystroke
Autologin (This is only available (but must be used when available) if security for the connected port is disabled)	F1 <i>See note below</i>
Add a character to the user name/password <i>See note below</i>	A-Z /0-9 or Shift + A-Z (upper and/or lower case characters)
Remove previous character from the user name/password	Backspace
Submit user name/password	Enter
Move from Name to Password field	Tab or Enter

If the password submitted is incorrect, the user will not be able to proceed.
If the password submitted is correct, the user will proceed to Normal Mode (see page 17).



Figure 31- User Login screen with security disabled

Once a user name and password is accepted, the UNIMUX will connect to the first CPU that is powered-ON and the user has access to. To enter Command Mode, press <Ctrl> + <~> (tilde/accnt key).

See the Command Mode functions described on page 24 to control the system of CPUs within the limitations as determined by the administrator.

Note: If security is not enabled, the message "Press F1 to Autologin" will appear in the login screen. While security is disabled, a standard user must press <F1> (see Figure 31) to access the switch. Only the administrator can login using the name and password when security is not enabled.

Additional OSD Modes Available With Security Enabled

Administration Menu

To access the Administration Menu press <A> from the Administrator's Main menu (see Figure 30). The Administration Menu can be accessed only when the administrator is logged-in. Users other than the administrator are not able to enter the Administration Menu.

If a different user is logged-in, log-out by pressing <L> from the Main menu, then log-in as Administrator. (See page 30, "Enabling Security".)

Administration Mode allows the administrator to use the following functions:

Function	Keystroke
Go to System Configuration menu	S
Go to Ports Configuration menu	P
Go to User Configuration menu	U
Change administrator's password	C
Display Usage Statistics	D
Ethernet Configuration	E
Exit from Administration Menu Return to Command Mode	Esc



Figure 32- Administration Mode Menu

System Configuration

To enter the System Configuration menu: press <S> from the Administration menu. The System Configuration menu can only be accessed when the administrator is logged-in.

Function	Keystroke
Change Idle Timeout	I
Change OSD Blank Timeout	O
Change Alternate Command Hot Key (See page 37 for details)	A
Reset the port names to default settings *You will be prompted to confirm this selection* <i>Note: The UNIMUX must be power cycled or the OSD Refreshed (main menu) for the reset to take effect.</i>	R
Configure the Keyboard Language	K
Open Security Configuration menu	S
Serial Baud Rate	B
Serial Address	E
Exit from System Configuration menu and return to Administration Menu	Esc



Figure 33- System Configuration menu

Port Configuration

To enter the Port Configuration menu: press <P> from the Administration menu. The Port Configuration menu can only be accessed when the administrator is logged-in.

The port configuration screen is used to edit the names of ports and to configure ports to be compatible with MAC or non-MAC CPUs. If the port will have a MAC CPU connected, use the mouse to click on the box associated with the port to place a check mark in the box.

Note: If a port is configured as connected to a non-MAC CPU, but is in fact connected to a MAC CPU, the mouse will still work as a generic mouse. No special functions provided by software drivers will be available.

Note: MAC mode must be enabled on any CPU ports that are connected to a CPU through an NTI ST-C5USBV extender.

Function	Keystroke
Open an edit field for the selected port to rename the port (see Figure 34). Names of CPUs can be up to 12 characters in length. Characters typed can be upper or lower case. Press <Enter> a second time to save the changes.	Enter
Configure all ports for MAC CPU connection	A
Configure all CPUs for non-MAC CPU connection	N
Open field in which you can type characters to quickly locate a specific port to be configured	F
Toggle the selected port between MAC and non-MAC configuration	Spacebar
Open Help window for this topic	F1
Exit from System Configuration menu and Return to Administration Menu. All changes made will be saved	Esc

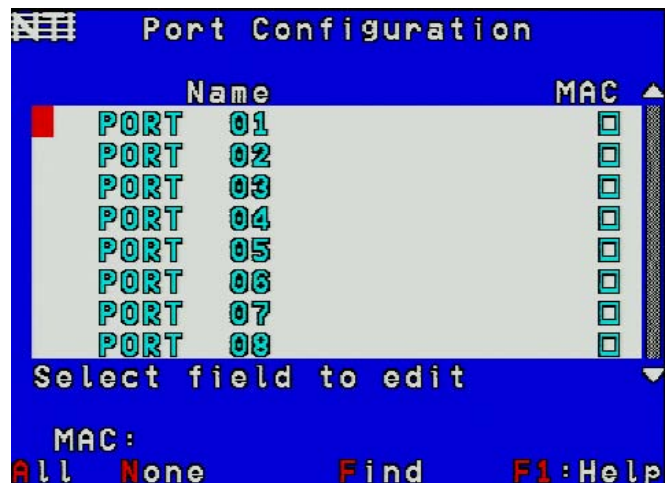

Figure 34- Port Configuration menu

- To save the change to characters in an edit field, press <Enter>.
- To exit an edit field without saving the changes, press <Esc>.

User Configuration

To enter the User Configuration menu: press <U> from the Administration menu. The User Configuration menu can only be accessed when the administrator is logged-in.

The User Configuration screen lists the users configured to access the UNIMUX. Up to 63 users can be assigned access.

To assign a user name, password, and port access control, select the user number or an empty record and press <Enter>, <E>, or click it with the mouse.

Function	Keystroke
Select previous user in the list	up arrow
Select next user in the list	down arrow
Scroll to previous 8 names	Page up
Scroll to next 8 names	Page down
Edit account for selected user	E
Exit and return to previous menu	Esc

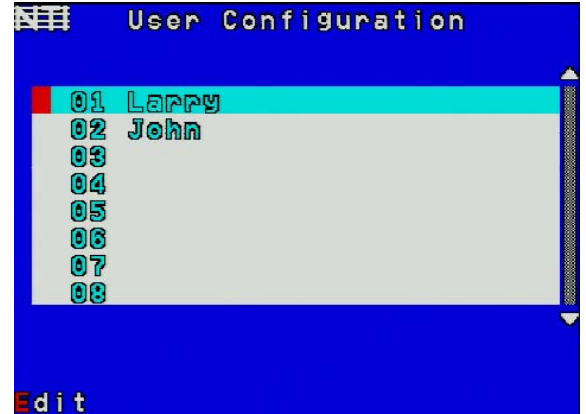

Figure 35- User Configuration

Edit User Account

The User Account mode (see Figure 36) enables the administrator to:

- add a new user
- remove an existing user
- edit the settings for an existing user

Function	Keystroke
Place edit field around the name- enabling it to be edited If no name is entered, a default name "userXX" (where XX is the user number) will be entered	N
Open an edit field to insert a user password- up to 15 characters in length If no characters are entered, no password will be required for that user	P
Usable characters for Name or Password (Upper and lower case characters can be used)	A-Z /0-9 or Shift + A-Z
Open an edit field to confirm the password by retyping	C
Close an edit field	Enter
Open access control list for the user, to assign ports the user will be able to connect to For new users, by default, no ports are user accessible unless selected by the administrator	A
Delete all account information for the selected user	D
Exit and return to previous menu	Esc
Changes made will be saved automatically	

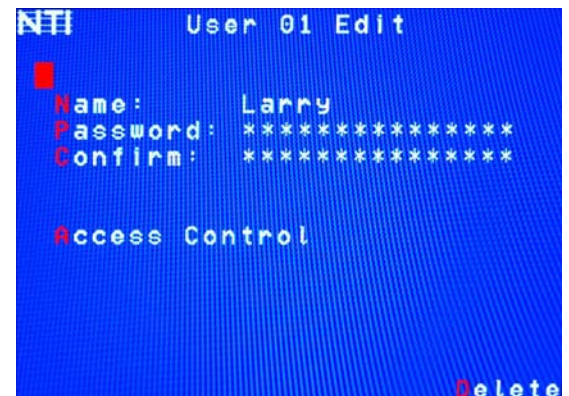

Figure 36- User Account menu

Note: To change the characters of a name while in the edit field, type the new characters or use the <Spacebar> to overwrite the existing characters. Pressing the <Delete> key will have no effect on existing characters and the <Backspace> key will only work if the cursor is at the end of the edit field. Use the <left arrow>, <right arrow>, <home> or <end> keys to move the cursor while in editable fields.

User Access Control

To enter the Access Control list for a user, press A from the User Account screen for that user. From the Access Control list the administrator can:

- select all ports to have access to
- deselect all ports so that none can be connected to
- select only a limited number of ports to be accessed

The Access Control list is a check list with all the port numbers displayed

- unchecked box = the corresponding port is **not** in the access list
- checked box = the corresponding port **is** in the access list

Function	Keystroke
Toggle the state of the selected check box	Spacebar
Select the next or previous port	up or down arrow
Quickly place check marks in all boxes	A
Quickly remove check marks from all boxes	N
Open Help window for this topic	F1
Exit and return to previous menu	Esc
Changes made will be saved automatically	



Figure 37- Access Control list

Change Administrator Password

To change the Administrator Password, press <C> from the Administration menu.

The Admin Password menu (see Figure 38) enables the administrator to change his password. Two edit fields are available, one for password, the other for verify password. The password can be up to 15 characters in length.

Note: The default password for the administrator is “nti”.

Function	Keystroke
Switch between Password and Confirm (password) fields	Tab
Add character to password string or confirm string	A-Z, 0-9 (upper or lower case)
Delete previous character in edited string	Backspace
Save new password. (The administrator will be prompted for a Yes or No confirmation)	S
Exit and return to previous menu	Esc

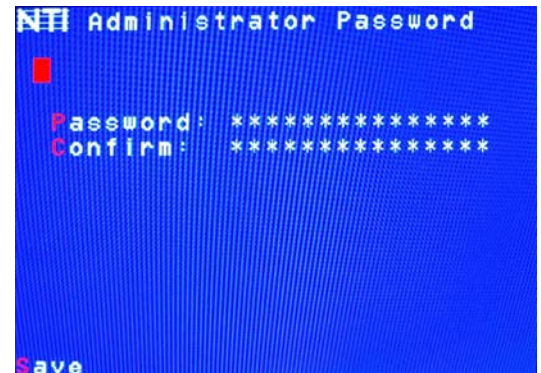

Figure 38- Administrator password menu

Note: If the confirmation password does not match the first password entered, the message “INVALID PASSWORD” will be displayed when you try to save it.

Display Usage

To display usage statistics for the UNIMUX, press <D> from the Administration menu.

The Display Usage page shows the user how many times the UNIMUX has been power cycled and how many total hours it has been powered ON. The counters for these statistics can be reset to 0 by pressing <F7> to reset the number of power cycles or <F8> to reset the hours of usage.

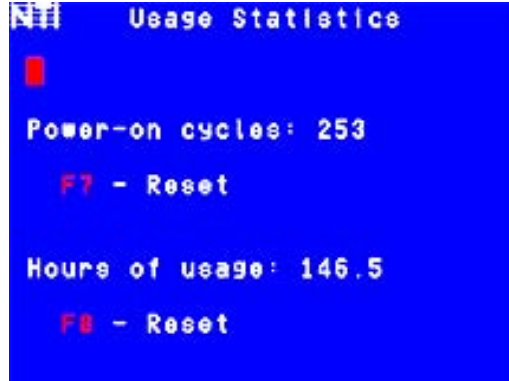

Figure 39- Usage Statistics Page

Ethernet Configuration

Not supported in this product

To configure the ETHERNET port settings on the UNIMUX for controlling the switch via Telnet Interface (page **Error! Bookmark not defined.**), press <E> from the Administration menu. The default values are shown in Figure 40.

Function	Keystroke
Change the IP Address	I
Change the Subnet Mask	S
Change the Gateway	G
Change the port number	T
Exit and return to previous menu	Esc

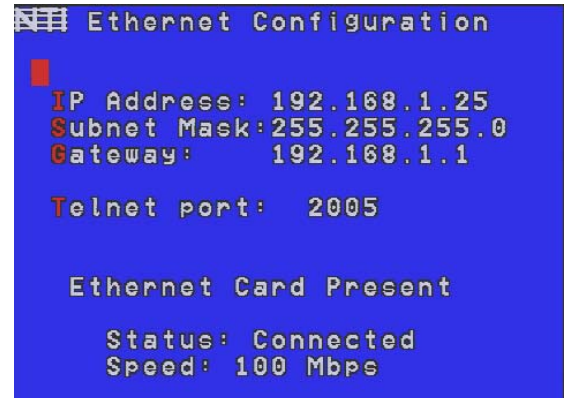

Figure 40- Ethernet Configuration

If the Ethernet feature is not present in the UNIMUX, the message "Ethernet Card Not Present" will appear at the bottom of this menu in Figure 40.

If the Ethernet port is present but not connected, the message "Ethernet Card Present, Status: Not Connected" will appear at the bottom of the Ethernet Configuration menu (Figure 40).

Note: The Ethernet port is not available when the CAT5 option is present.

Idle Timeout

The idle timeout is the amount of time that the user can be idle while in Command Mode before the user is automatically logged out. The idle timeout can be set to any value from 000 to 255 minutes. A value of 000 will disable it. After the idle timeout period has elapsed, the login screen will appear.

To change the Idle Timeout setting,

1. press <I> from the System Configuration menu (page 32) to display the edit field around the value (see Figure 41)
2. enter the desired value (000-255 minutes)
3. press <Enter> to save it and move to the next field
4. press <Esc> to exit the System Configuration menu



Figure 41- Change value of Idle Timeout

OSD Blank Timeout

The OSD Blank Timeout is the amount of time that the user can be idle while in Command Mode before the OSD menu will disappear. The time period can be set to any value from 000 to 255 minutes. A value of 000 will disable it. After the OSD disappears when the configured time period has elapsed, the user can make it reappear by either pressing a key on the keyboard or moving the mouse.

To change the OSD Blank Timeout setting,

1. press <O> from the System Configuration menu to display the edit field around the value (see Figure 42)
2. enter the desired value (000-255 minutes)
3. press <Enter> to save it and move to the next field
4. press <Esc> to exit the System Configuration menu

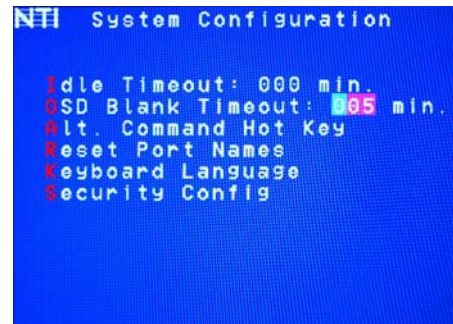

Figure 42- Change the value of OSD Blank Timeout

Alternate Command Hot Key

To enable the administrator to assign a key in addition to the <`> (accent/tilde key) to use with <Ctrl> to enter into OSD Command Mode, an Alternate Command Hot Key option is provided. The default factory setting for this option is <`> (disabling the option).

To select an Alternate Command Hot Key, press <A> from the System configuration menu (page 31). A window will open and the administrator will be prompted to press a key. Any key **except** Ctrl, Shift, Alt, Tab, Esc, or Enter can be used. After pressing the key, a confirmation message will appear. The administrator should press <Y> (Yes) to validate the key as the Alternate Command Hot Key, or <N> (No) to select another key.

Pressing <Esc> will return to the Administration Mode menu.

Only the administrator is able to set or change the Alternate Command Hot Key. This function must be set individually for each of the USB User Device ports on the UNIMUX USB KVM switch.

Note: The Alternated Command Hot Key does not replace the <`> (accent) key, it just works as another way to enter into Command Mode. After setting it, the user can enter into Command Mode either with <Ctrl> + <`> or with <Ctrl> + <Alternate Command Hot Key> combination. To disable it, the administrator should set <`> as the Alternate Command Hot Key.

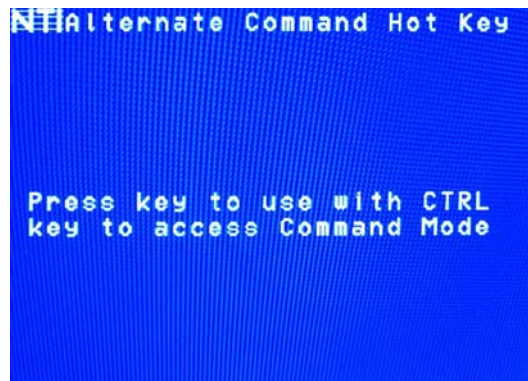

Figure 43- Alternate Command Hot Key selection window

Reset Port names

To erase all configured port names and return them to the factory-default names, press <R> from the System Configuration menu. After pressing the key, a confirmation message will appear. The administrator should press <Y> (Yes) to validate the selection or <N> (No) to cancel it.

Pressing <Esc> will return to the Administration Mode menu.

The switch must be power cycled for the reset to take effect.

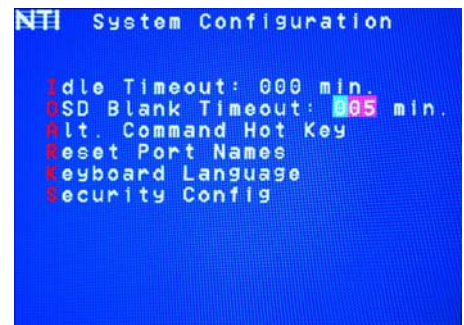

Figure 44- Press "R" to reset port names

Select Keyboard Language

To enter the Select Language menu (see Figure 45) press **K** from the System Configuration menu described on page 32. Only the administrator has the Select Language menu option.

The Select Language menu enables the administrator to select a specific keyboard language (country code) to be used. Typically only SUN CPUs require a specific country code to be registered at boot up. (For other types of CPUs this feature may have no effect.) A list of available languages is displayed and can be scrolled using the mouse (scroll wheel) and/or <up arrow>, <down arrow>, <Home> and <End> keys.



Figure 45- Select Language menu

- To manually program a specific language, select a language and press <Enter> (or click the left mouse button).
- To automatically detect the language of the keyboard, select "AutoDetect" and press <Enter> (or click the left mouse button) . The list will advance to the actual detected keyboard language and that language will be programmed.

Some keyboards don't have a country code. In this case the selection will remain in the "AutoDetect" position and the default country code "00" will be programmed in the UNIMUX. If a specific country code is manually programmed, it will be the country code for the switch, regardless of the actual country code of the connected keyboard. The programmed country code is saved in memory and restored each time the UNIMUX is powered-ON. Because the CPUs that use country code (i.e. SUN CPUs) read it at boot time, it is necessary to boot the CPU(s) after programming the country code.

Security Configuration

The UNIMUX can be configured to either have no security enabled such that any user can connect to the UNIMUX, or have security enabled such that a user must have a login name and password in order to enter Command Mode and make a connection with an accessible CPU. Only the administrator has access to Security Configuration.

Within Security Configuration, the administrator has three options:

Function	Keystroke
Enable security just for the user port that his currently connected through	U
Enable Global Security- security enabled on all user ports	E
Disable Global Security- security disabled on all user ports	D
Return to previous menu	Esc



Figure 46- Security Configuration

If Security is disabled and the user attempts to login to Command Mode with the command key, the login screen will include the instruction "Press F1 to Autologin".

With security disabled, Autologin provides full access to all connected CPUs and all users except the administrator must use it to login.

When security is enabled, Autologin is not available and the user must login using the administrator assigned user name and password. The user will have access to only those CPU ports as configured by the administrator.



Figure 47- Login screen with security disabled

Serial Baud Rate

The serial baud rate for the UNIMUX can be changed by pressing from the System Configuration menu. In order to control the UNIMUX via RS232 (page 43), the baud rate must be set the same as the communication port on the control terminal attached to the UNIMUX (page **Error! Bookmark not defined.**)

The baud rate value can be set to 115000, 57600, 38400, 19200, 9600, 4800, 2400, or 1200. A data protocol of 8 data bits, no parity, and 1 stop bit is used for communications. With the edit field highlighted, press the <Left arrow> or <Right arrow> to change the value of the baud rate.

Note: The baud rate can also be changed from the RS232 Command Protocol (see page 43).

For more on RS232 Control, see page 43.



Figure 48- Adjust Baud Rate

Serial Address

To allow multiple UNIMUXs to be controlled from a single control terminal, the RS232 control interface is designed to allow "daisy chaining" up to 15 units. Each unit must be assigned a unique address. The unit address for the UNIMUX can be changed by pressing <E> from the System Configuration menu. With the edit field highlighted, press the <Left arrow> or <Right arrow> to change the value of the unit address. The address range is 1-15. For more on daisy chaining, see page 43.

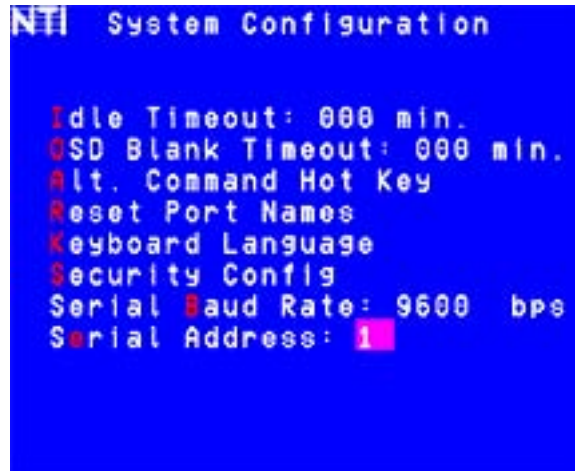

Figure 49- Adjust Serial Address

Keyboard Mapping

The keyboard configuration of each CPU is saved in the UNIMUX switch. For example, if the CPU attached to Port 4 had CAPS LOCK and NUM LOCK selected the last time that CPU was accessed, then they will automatically be set when that CPU is accessed again.

Key Equivalents

Using the chart below, find the character needed to be typed on the CPU being accessed, then follow the row across for the equivalent on the keyboard being used. (See Figure 50 on page 42 for reference.)

USB 101	WINxx	MAC (Apple USB)	SUN
L-Ctrl	L-Ctrl	L-Ctrl	L-Ctrl
L-Alt	L-Alt	L-Option	L-Alt
SB+F12	Application	SB+F12	Compose
R-Alt	R-Alt	R-Option	Alt-Graph
SB+Alt	Windows Logo	Command	Meta
SB+R Arrow	SB+R Arrow	Power	Suspend

SB = Space Bar

L and R = Left and Right keys when two keys are marked the same on a keyboard.

Mouse Click Equivalents

To emulate a right button click using Apple 1 button mouse, hold down the Command key () while pressing the mouse button.

Note: Right mouse button emulation must be enabled (see Settings on page 26) for this to work.

SUN's 16 Extra Keys

101, WINxx, MAC Keyboards	SUN Extras
SB+F1	Stop (L1)
SB+F2	Again (L2)
SB+F3	Props (L3)
SB+F4	Undo (L4)
SB+F5	Front (L5)
SB+F6	Copy (L6)
SB+F7	Open (L7)
SB+F8	Paste (L8)
SB+F9	Find (L9)
SB+F10	Cut (L10)
SB+F11	Help
SB+F12	Compose
SB + Up Arrow	Vol +
SB + Down Arrow	Vol -
SB + L Arrow	Mute
SB + R Arrow	Suspend

Use the chart to the left to type SUN's additional 16 keys using a 101, WINxx, or MAC (Apple) USB keyboard

SB= Space Bar

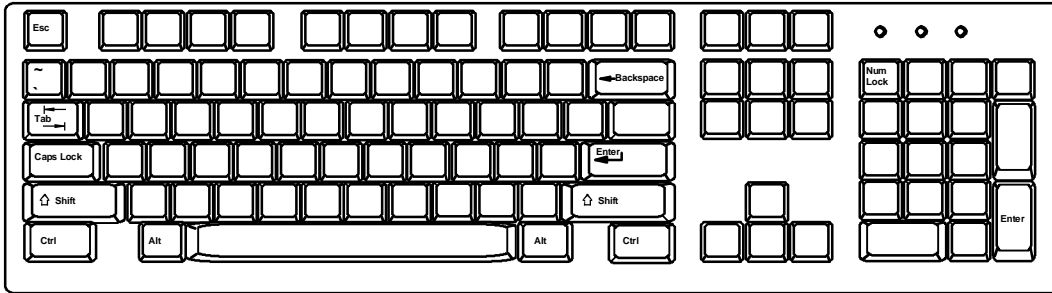

Typical 101 Keyboard

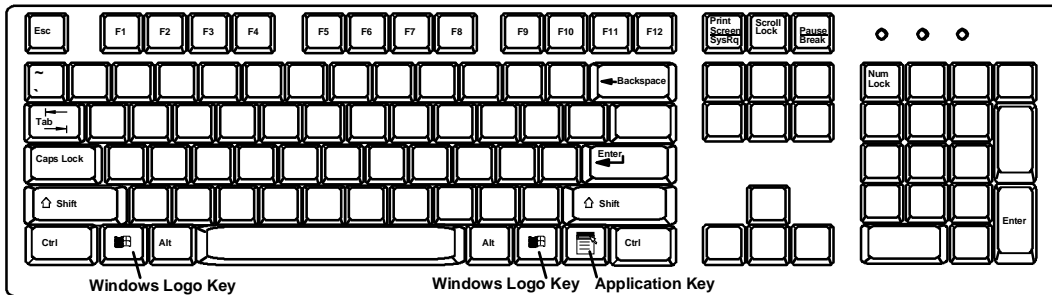

Windows Keyboard

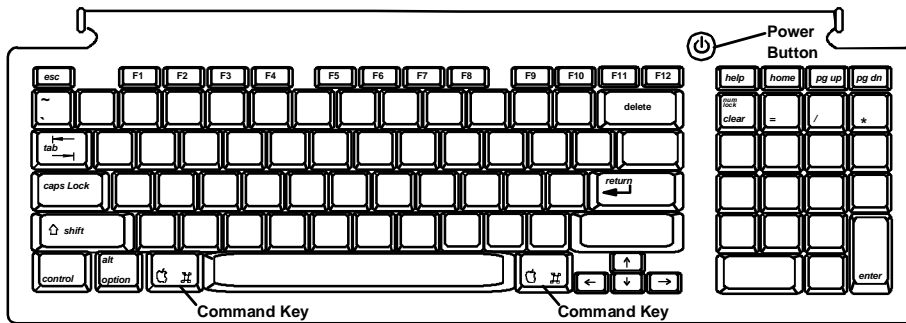

Apple USB Keyboard



SUN USB Keyboard

RS232 CONTROL

RS232 enables the UNIMUX to be remotely controlled via RS232. To control the UNIMUX via RS232 the user has three options:

- write a program that runs on a PC using the Command Protocol (page 45)
- use the NTI Switch Control Program (page 46) provided on the CD
- use the SerTest or RMTEST programs (pages 46 and 48) provided on the CD

Remote Connection

The RS232 Interface is designed to meet the RS232C standard and can be controlled from any CPU or other controller with an RS232 communications port. The pin-out for the RJ45 connector on the unit is as follows:

RS232 (RJ45) CONNECTOR

PIN	SIGNAL	FUNCTION
1	-	No connection
2	-	No connection
3	RX+	Receive data (TXD at host)
4	GND	Ground
5	-	No connection
6	TX+	Transmit data (RXD at host)
7	-	No connection
8	-	No connection

NOTE: Security must be disabled or user access granted on the port(s) to be selected by RS232 control.

A 5 foot patch cable and two adapters, RJ45-to-DB9 and RJ45-to-DB25, have been provided for connection to most CPUs (see page **Error! Bookmark not defined.**). To daisy chain multiple units, connect a Matrix-Y-1 cable (sold separately) between the CPU and the first switch, and between each switch (as shown in Figure 51).

Baud Rate

The baud rate can be changed using the OSD menu (page 43) or from the RS232 commands (page 45). The baud rate can be set to 115000, 57600, 38400, 19200, 9600, 4800, 2400, or 1200. A data protocol of 8 data bits, no parity, and 1 stop bit is used for communications.

Unit Address and Loop Back

To allow multiple units to be controlled from a single host port, the RS232 control interface is designed to allow "daisy chaining" up to 15 units using an NTI Matrix-Y-1 cable. Connect the Matrix-Y-1 cable between the RJ45-to-DB9 serial adapter and the CPU as shown in Figure 51. By setting the appropriate unit address (page 43), each unit can be given a unique address (1-15). Then the unit will only respond to commands on the bus if its address is embedded in the command.

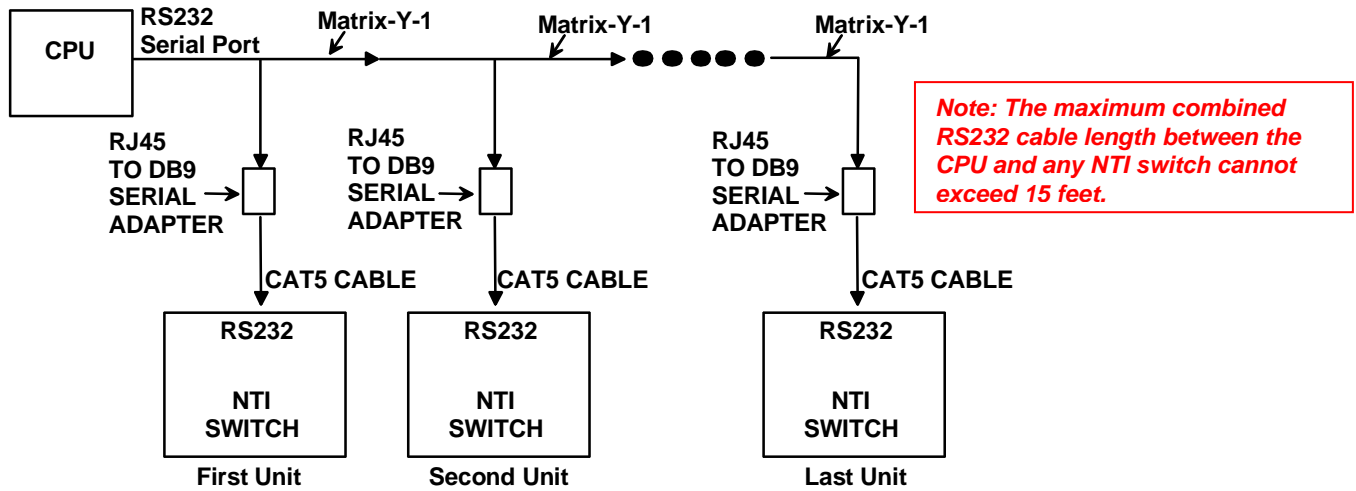

Figure 51- RS232 connection with Matrix-Y-1 cable

Wiring Schematic of Matrix-Y-1 cable

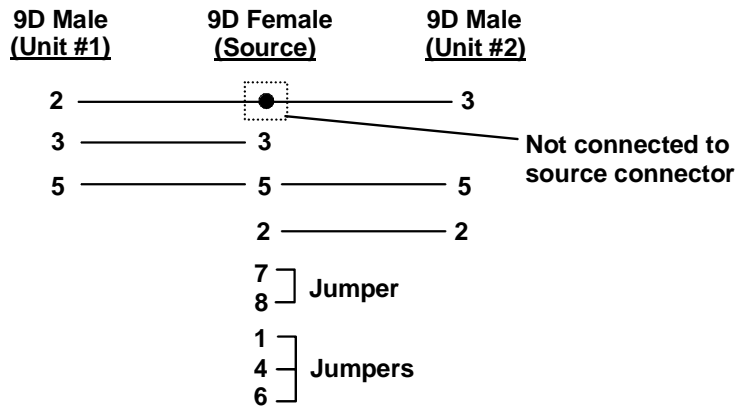

Figure 52- Pinout of Matrix-Y-1 cable

RS232 Command Protocol

Host controller commands supported by the unit are defined below.

RS232 Command Protocol Quick Reference

Legend: (All numbers must be two digits)

SW : Switch (01-15)

BR : Baud Rate Code

OP : Output/User Port

IP : Input Port/CPU (01-MAXINPUTS)

<CR>: Carriage Return (Hex 0xD)

Command String	Good Response	Description
CS SW,IP,OP	*<CR>	Connect one User port To CPU port
RO SW,OP	*<CR>IP<CR>	Read Connection For User Port
CB 00,BR	None	Change Baud Rate For All Switches BR = 12 (1200), 24 (2400), 48 (4800), 96 (9600), 19 (19200), 38 (38400), 57 (57600), 11(115000) (9600 is the default)
RV SW,00	*<CR>string\0<CR>	Read NTI Version String
RU SW	*<CR>IP,OP<CR>	Read Unit Size
SS SW,00	*<CR>	Disable Autostatus feature (see below)
SS SW,01	*<CR>	Enable Autostatus feature (see below)
GM SW,00	*<CR>go SW OP IP<CR> (all connections)	List all switch User port connections; all User ports to all CPU ports

If the first field is not a known command (as listed above) or SW field is different from the serial address programmed in the switch memory, the command will be ignored. If the SW field corresponds to the serial address, but the syntax is wrong after this field, the switch will answer with ?<CR>.

Syntax example:

CS 01,05,01<CR> (insert the space and commas as shown)

which means "At the switch with unit address 01, connect CPU port 05 to user port 01"

The switch will answer with:

*<CR>

The HEX code representation of example above is:

Byte 1	Byte 2	Byte 3	Byte 4	Byte 5	Byte 6	Byte 7	Byte 8	Byte 9
'C' (0x43)	'S' (0x53)	Space (0x20)	Switch – 1st digit (0x30)	Switch – 2nd digit (0x31)	',' (0x2C)	Output – 1st digit (0x30)	Output – 2nd digit (0x35)	',' (0x2C)

Byte 10	Byte 11	Byte 12
Input –1st digit (0x30)	Input –2nd digit (0x31)	<CR> (0x0D)

Response:

Byte 1	Byte 2
'*' (0x2A)	<CR> (0x0D)

Autostatus

When Autostatus is enabled, any output-to-input connection change in the UNIMUX will cause an Autostatus message to be sent via RS232 to the administrator. The format of the message would be "pc SW,OP:IP<CR>"

Example of an Autostatus message:

pc 01,01:04<CR>

which means "At the switch with unit address 01, the output (01) has changed connection to input 04."

Notes: Message to the administrator will be delayed by any RS232 traffic being received by the switch from the administrator.

Autostatus must be disabled before using SerTest or the NTI Switch Control Program (below).

By default, Autostatus is disabled and must be manually enabled. Autostatus is also disabled any time the power to the UNIMUX is interrupted.

NTI Switch Control Program For Windows 9X, NT, 2000, XP and Vista

The NTI Switch Control Program is an easy and powerful graphical program that controls NTI matrix switches through an RS232 interface. The NTI Switch Control Program is included on the CD packaged with the UNIMUX. The NTI Switch Control Program is downloaded by clicking on the link "Download NTI Switch Control Program" found on the webpage the opens when the CD is inserted into the CDROM drive.

To install the NTI Switch Control Program after downloading

1. Locate the **Setup.exe** in the directory the program was downloaded to and double-click on it
2. Follow the instructions on the screen

Note: In order to use the NTI NTI Switch Control Program to control the UNIMUX, the UNIMUX RS232 port must be set at a baud rate of 9600 bps (see page 43).

The NTI Switch Control Program performs best on monitors set to a screen resolution of at least 800 X 600. Instruction for using the NTI Switch Control Program is available by opening "MSCP Help" in the "NTI" program group once the program has been installed and is open on the screen.

To open "MSCP Help" from the Windows desktop

1. Click on **START**
2. Click on **PROGRAMS**
3. Click on **NTI**
4. Click on **MSCP Help**

SerTest- RS232 Interface Test Program

This software allows a user to test the functions of an NTI server switch, matrix switch or Multi-user/Multi-platform switch RS232 interface. The program SERTEST along with the NTI Switch Control Program (page 46) is installed from the CD packaged with this switch. SERTEST generates a main menu with the selections described below:

Main Options

- Matrix Operations - send commands to the matrix unit.
- Ethernet Operations - set Ethernet connection variables (not applicable to this product)
- Setup Options - set COM port, baud rate, and unit address
- About SerTest - display the program version

Matrix Operations

Key	Selection	Description
1)	Connect Output/User to an Input/CPU	- connect an output to an input
2)	Connect All Outputs/Users to an Input/CPU	- connect all outputs to an input
3)	Connect Audio Output/User to an Input/CPU	- connect an output to an input (audio ports only)
4)	Connect All Audio Outputs/Users to an Input	- connect all outputs to an input (audio ports only)
5)	Change Mute Status for Audio Output/User	- mute or un-mute the Audio port output
6)	Change Volume for Audio Output/User	- change Audio port output volume
7)	Read Connection for Video Output/User	-read the connection of a specific video output
8)	Read Connection for Audio Output/User	-read the connection of a specific audio output
9)	Read Mute and Volume for Audio Output/User	- read the volume and the mute status of the specified output (audio ports only)
a)	Save I/O Connections into Unit Memory	-save the connections into switch memory bank
b)	Restore I/O Connections from Unit Memory	-restore the connections from switch memory bank
c)	Change All Units Baud Rate (9600/COM1:)	-change RS232 Baud rate of all switches -the current baud rate and serial port are displayed in parentheses
d)	Reset Unit	- send a reset command to the switch (This command does not function at this time)
e)	Reset All Units	- send an internal reset command to all switches
f)	Read Unit Size	- read the switch size (number of inputs and outputs)
g)	Read Unit Version/Revision String	-read a string containing the switch version, type, and size
h)	Save All Units I/O Connections into Units Memory	-save the connections into switch memory bank, command for all switches
i)	Restore All Units I/O Connections from Units Memory	-restore the connections from switch memory bank, command for all switches

Selections in the "Key" column that are gray are not applicable to this product.

Setup Options

Key	Selection	Description
1)	select Com port current: (COM1:)	- select PC serial port - the current PC serial port is displayed in parentheses
2)	select Baud rate current: (9600)	- select PC serial port baud rate - the current baud rate is displayed in parentheses
3)	set unit Address current: (1)	- select the unit address - the current address is displayed in parentheses

For any selection that requires user input, the user is prompted. When commands are sent to the matrix unit, the command string and matrix unit responses are echoed to the screen. All commands generated by the program are formatted according to the information provided in sections above. If any transmission problems are detected, an error message is displayed.

Press <Esc> or <Enter> to back out to the main menu and press again to exit.

RMTEST-RS232 Interface Test Program

This software also allows a user to test the functions of an NTI server switch, matrix switch or Multi-user/Multi-platform switch RS232 interface. The RMTEST program is automatically loaded when installing the NTI Switch Control Program as described on page 46. The RMTEST program, located in the NTI program group, generates a main menu with the 3 selections described below:

MAIN OPTIONS

1. Matrix Options - send commands to the matrix unit.
2. Setup Options - set COM port, baud rate, and unit address
3. Quit - quit the program

If Matrix Options is selected, the following menu, which has 7 options, is displayed:

MATRIX OPTIONS

1. Reset single unit - reset single matrix to power-up defaults (matrix switch only)
2. Reset all units - reset all daisy chained matrix units (matrix switch only)
3. Change single output - connect an input to one output
4. Change all outputs - connect an input to all outputs
5. Read single output - read which input is connected to an output
6. Read unit size - read how many inputs and outputs the unit has
7. Return to main menu - go back to the MAIN OPTIONS menu

The Setup Options main menu selection only needs to be executed if the switches baud rate or unit address have been changed from the factory defaults (9600 baud, and unit address = 1). When this option is selected, the following menu, which has 4 options, is displayed:

SETUP OPTIONS

1. Set COM port (default = COM1) - set port to COM1-COM3
2. Set baud rate (default = 9600) - set baud rate (see interface manual for supported baud rates)
3. Set unit address (default = 01) - set the unit address (if multiple units are daisy-chained)
4. Return to main menu - Go back to the MAIN OPTIONS menu

For any selection that requires user input, the user is prompted. When commands are sent to the unit, the command string and unit responses are echoed to the screen. All commands generated by the program are formatted according to the information provided in the sections above. If any transmission problems are detected, an error message is displayed.

SUN RAY SUPPORT

The UNIMUX fully supports SUN Ray CPUs, however, a lack of horizontal mouse movement may be experienced. If this occurs, enable MAC mode (page 32) for the port that the SUN Ray is connected to. This should enable proper mouse movement.

FIRMWARE UPGRADE PROCEDURE

This procedure describes how to upgrade the firmware in the UNIMUX switch. If you are not certain whether this UNIMUX has the most up-to-date firmware available, see page 55 for instruction on how to determine what version the UNIMUX has. All versions of firmware can be downloaded from the NTI firmware download website at <http://www.networktechinc.com/download/d-srvsw-usbu-hd.html>.

The UNIMUX switch has 3 types of micro-controllers:

1. Main User Controller – there is only one on each UNIMUX and it will be upgraded with a binary file named **unimux-suhd-csx-x.bin. (where x-x is the rev number)**
2. HID Port Controller – there is one HID Port Controller for each CPU port available on the switch – it will be upgraded with an Intel hex file named **unimux-suhd-cpkmx-x.hex**. Each CPU port is upgraded independently.
3. Vendor Specific Port Controller – there is one such controller for each CPU port available on the switch – it will be upgraded with an Intel hex file named **unimux-suhd-cpvd-x-x.hex**. Each CPU port is upgraded independently.

The UNIMUX firmware has a bootloader which can be used for firmware upgrades. The bootloader resides in a protected area of Flash memory, so that if the upgrade fails for any reason, the bootloader will still be available to be used to re-program the entire unit.

Upgrades can be made to the User Controller, HID Port Controller, or Vendor Specific Port Controller on an individual basis as needed. Not all CPU ports must be at the same revision level for the UNIMUX to work, but it is highly recommended that if you upgrade one CPU port, you upgrade all CPU ports on a switch.

Requirements

- CAT5 Patch Cable (supplied with UNIMUX)
- RJ45-DB9 or DB25 Adapter (supplied with UNIMUX)
- Computer with a Terminal Console (for example, HyperTerminal in Windows, or any similar program able to send files using Xmodem protocol)
- Firmware files for the UNIMUX on the computer with the Terminal Console.

Preparation For Upgrade

1. With the power to the UNIMUX OFF, connect the computer to the UNIMUX as shown in the figure below.

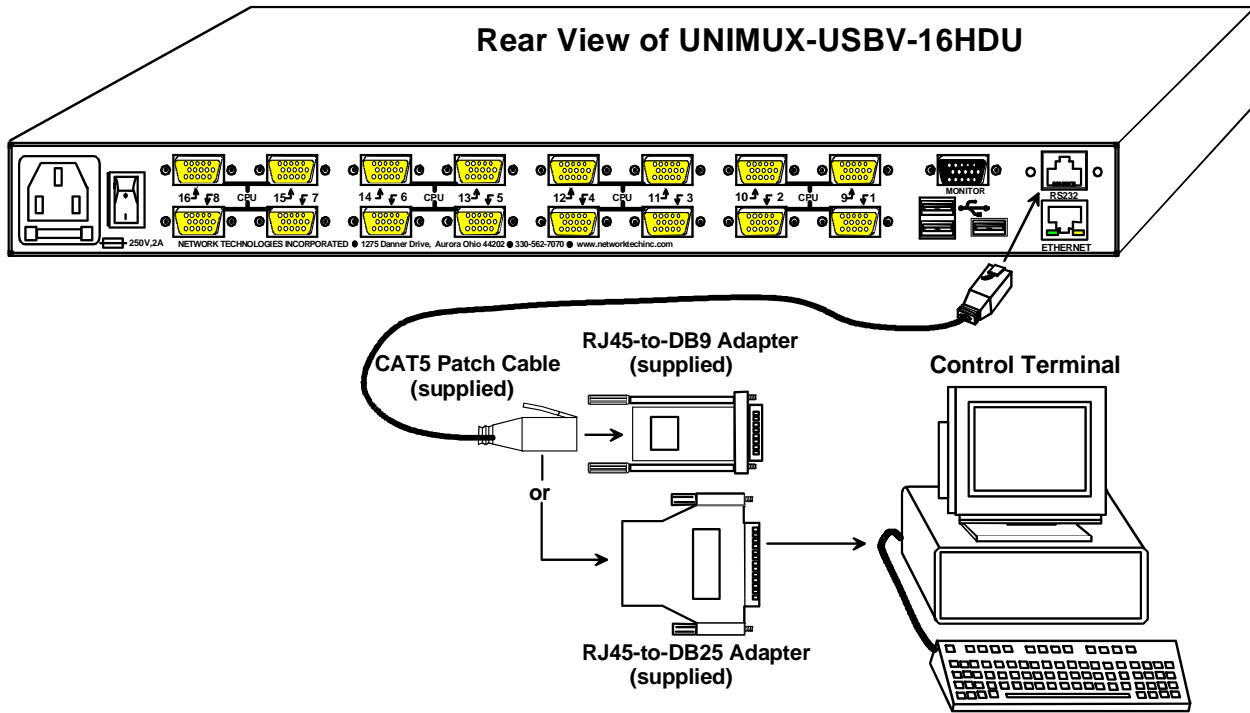

Figure 53- Preparation for firmware upgrade

2. Power ON the computer only. Open the terminal console and apply the following settings to the terminal console for the port connected to the UNIMUX:

Baud rate: 57600

Data bits: 8

Parity: none

Stop bits: 1

Flow control: none

Upgrade Procedures

Start the Bootloader

In the HyperTerminal window on the attached computer, press **and hold** the <Tab> key and power ON the RACKMUX. The following message (or one similar) will be displayed on the screen:

```
UNIMUX-HD-NxM Bootloader
Revision: 1.1
Date: 2008/09/11 15:40:16
Copyright (C) Network Technologies Inc.

Press <H> for help..
>
```

Release the <Tab> key.

The ">" prompt indicates that the bootloader is waiting for commands. The available commands are composed by sending one ASCII character. To send a command to the bootloader, type the key in the terminal window that corresponds to the desired command. The available commands, listed below, can be viewed by typing <h> or <H> (the Help command) from the keyboard.

Note: Commands can be typed using upper or lower case letters.

```
Commands:
-----
h, H - Display list of commands
x, X - Exit Bootloader
u, U - Upgrade user controller firmware
p, P - Upgrade HID port controller firmware
v, V - Upgrade vendor specific controller firmware
s, S - Read Checksum of the HID port controller firmware
t, T - Read Checksum of the vendor specific controller firmware
```

Update the User Controller Firmware

Note: The User Controller Firmware update only needs to be done once, whether the UNIMUX switch is a single-user, or a multi-user model.

The user controller firmware comes as a file in binary format and has the extension .bin. (i.e. filename.bin). To upgrade the user controller to this file, press <u> from Terminal window. The following message should appear on the screen:

```
Erasing flash memory...
Memory successfully erased
Send .bin file using Xmodem protocol..
```

At this point the binary file **unimux-suhd-csx-x.bin** must be sent. To do this, from HyperTerminal:

1. go to "Transfer" menu in the Menu Bar of the HyperTerminal window
2. click the item "Send File ..."
3. in the dialog box which pops up on the screen, browse for the file to be sent and select it
4. select "Xmodem" from the Protocol drop-down menu
5. press "Send" button

The transmission will start shortly. Wait until the transmission is finished. There will be some pauses during transmission, since the processor writes blocks of 4KB.

When the transmission is complete, the HyperTerminal window should show the following status message and return to the menu prompt:

```
Device successfully programmed!
```

```
>
```

To exit from the bootloader, press <x>.

Update the HID Port Controller Firmware

The HID port controller firmware comes as a file in Intel Hex format and has the extension .hex (i.e. filename.hex). To upgrade any of HID controllers (there is one per CPU port) with this firmware, press <p> from the terminal window. The following message should appear on the screen:

```
Send .hex file using XModem protocol...
```

At this point, the hex format file **unimux-suhd-cpkmx-x.hex** has to be sent, using HyperTerminal and the same procedure as before. When the transmission is done, the following message will be shown in the HyperTerminal window:

```
File transfer OK!
Please, type the two-digit number of the port to be updated,
<A> to program all or <X> to exit
(the two-digit number should be between 01 and nn,
where nn is the number of available ports):
```

To program only one device (CPU port), the corresponding port number must be typed (two-digit number, zero leading, number between 01 and the last CPU port number, depending on switch size). **To program all devices**, just press <a>).

The following message will be shown on the screen (it may take about 12 seconds to program each device):

```
Programming device, please wait...
```

```
Device ID: 0x001E  
Device successfully programmed!
```

The bootloader will then ask again for a port number.

To program another port, type the two-digit number of the port,
To exit from this function and the bootloader, press <x>.

If <a> was pressed instead of a single port number, and all devices were programmed, the message above will be repeated for each port that was programmed. After all are programmed, unless the switch has 32 CPU ports, the following message will be shown on the screen

```
Programming device, please wait...
```

```
Device ID: 0x0000  
Device failed!  
Error Code 1
```

This is shown because the bootloader continues to look for devices until it has found up to 32 (the maximum number of possible CPU ports a single UNIMUX can have). If it doesn't find another port, the procedure will fail and discontinue. On switches with fewer than 32 ports, this is normal.

To exit from the bootloader, press <x>.

Update the Vendor Specific Port Controller Firmware

Updating the vendor specific port controller firmware is similar to updating the HID port controller firmware (described on page 3). The only differences are that key <v> is used to enter this command and the hex file to send will be **unimux-suhd-cpvd-x-x.hex**

To exit from the bootloader, press <x>.

Read the Checksum of HID or Vendor Specific Port Controller Firmware

Reading firmware checksum is useful to determine the version of software running on port controllers. While the firmware revision for user controller can be found on the UNIMUX splash screen when it is powered-ON, the firmware revision of port controllers is not displayed anywhere. Reading checksum is an easy way to identify the current firmware revision in your UNIMUX and to determine if a new firmware revision is available for download.

To read the checksum, type **<s>** for HID port controllers or **<t>** for vendor specific port controllers, at the bootloader prompt. The following message will be displayed:

```
Please, type the two-digit number of the port to be checked,  
<A> to check all or <X> to exit  
(the two-digit number should be between 01 and nn,  
where nn is the number of available ports):
```

To read the checksum for only one device, type the number of the port (two digits, leading 0). To read the checksum for all ports type **<a>**.

The device ID and the checksum will be displayed in the following format:

```
Device ID: 0x001E  
Device Checksum: 0x3AB1
```

The checksums for all revisions of UNIMUX firmware can be found on the NTI download webpage at <http://www.networktechinc.com/download/d-srvsw-usbu-hd.html>.

To exit from the bootloader, press **<x>**.

SAFETY

This NTI product has been designed and fully tested with user safety of the utmost importance. As with all electronic devices, this NTI product should be handled and operated with care. In order to avoid possible injury and to reduce any risk of damage to this product, please read and follow each of these safety instructions.

- Follow all instructions found in this manual.
- Follow all instructions found on the product.
- Do not attempt to perform any service on this product unless specifically instructed to in this manual.
- Objects that can damage or be spilled on this product should be kept away from this product. Liquids, if spilled, could come into contact with voltage points causing a risk of fire or electrical shock.
- Always unplug this product before cleaning it. Do not use any liquid or aerosol cleaners to clean it.
- Do not install or use this product near water
- Be sure to mount this product on a solid, stable surface or in a rack (if applicable)
- Route all cables and the power cord away from sharp edges or objects that could cause damage to them
- Use only the power cord or AC adapter that came with this unit or one that meets the requirements specified in this manual
- Use only a properly grounded 3-wire electrical outlet for power connection
- Unplug this product and contact NTI should any of the following conditions occur:
 - The power cord or connection cables have been damaged
 - The product has come into contact with any liquids
 - The product does not operate properly despite having followed all of the instructions
 - The product has been dropped or the case has been damaged in any way
 - The product performs distinctly different than it did when first put into service

RACKMUX-KVM DRAWER STANDARD SPECIFICATIONS

General Specs

Case Material.....	Electro-galvanized steel black powdercoated
Dimensions WxDxH (in.).....	19 x 21.9 x 1.75
Supported Rack Depths.....	Adjustable 22" – 39"
Weight.....	26 lbs.
Input Power.....	AC 100-240V, 50 – 60 Hz
Operating Temperature.....	0-40° C
Storage Temperature.....	-20-60° C
Relative Humidity.....	20-90%, non-condensing
Approvals.....	All parts comply with RoHS

LCD – 17"

Display area.....	337.92mm (W) x 270.336 (H) (17 inch diagonal)
Panel Type.....	TFT Active
Number of Pixels.....	1280 (H) x 1024 (V)
Number of Colors.....	16.2 Million (6 bits + FRC)
Pixel Pitch.....	0.264(H) x 0.264(V)
Color Pixel Arrangement.....	RGB Vertical Stripe
Brightness.....	300cd/m ² (Nits)
Response Time.....	5.5ms
Viewing Angle.....	Horizontal: 140°; Vertical: 130° (Typ.)
Optimum Viewing Direction.....	6 o'clock
Backlight Unit.....	CCFL, 4 Tables, Edge-Light (2 Top/2 Bottom)
Operating Lamp Life.....	40,000 – 50,000 hrs
Contrast Ratio.....	500:1

Display Controller: VGA

Connector.....	15HD, female
Video Format.....	VGA, SVGA, XGA, SXGA (17" and 20" only), UXGA (20" only)
Signal Input (from Video Source).....	Analog RGB
Sync Range.....	H: 31 ~ 80KHz, V: 55 ~ 76Hz
OSD Control.....	Menu, Up, Down, Select, Power (5 keys)
Plug and Play.....	VESA DDC 2B Ver1.3

OSD Control Board

OSD Control.....	5 Keys
Power Key.....	Power ON/OFF
Menu Key.....	Activates Menu
Up, Down Keys.....	Navigation Control
Select Key.....	Select (when in Menu); Auto Adjust (not in menu)
LED.....	Indicates Operation Status
.....	Green = Power-ON, Video Input OK
.....	Red = Suspend / Stand-by, or Input Out of Range

Keyboard

No. Of Keys.....	83 Keys (US), 84 keys (German, French, Italian, Spanish)
Key Switch Type.....	Membrane switch
Keytop Style.....	Rectangular Cylindrical
Operating Force.....	50gf +/- 25gf
Stroke.....	3.0mm +/- .5mm
Tactile.....	20 gf typ.
Height.....	8.5 mm
Operating Life.....	10M operations, minimum
Interface.....	Row and column matrix
Key Switch Bounce.....	10 ms, maximum
Supported Platforms.....	USB, PS/2
CPU Connectors.....	USB Type B (USB);
.....	6-pin miniDIN, female, Purple & Green (PS/2)

Touchpad

Motion Detection Method	capacitance sensing
X/Y Position Sensing Resolution	40 counts/mm
X/Y Position Reporting.....	Relative (Similar to mouse)
Tracking Speed.....	Up to 1016 mm/sec
Touch Force.....	No Contact pressure required
Lifetime (Plastic Overlay)	Minimum 10,000,000 strokes
Sample Rate	Up to 100 samples/sec

TROUBLESHOOTING FOR KVM DRAWER

Each and every piece of every product produced by Network Technologies Inc is 100% tested to exacting specifications. We make every effort to insure trouble-free installation and operation of our products. If problems are experienced while installing this product, please look over the troubleshooting chart below to see if perhaps we can answer any questions that arise. If the answer is not found in the chart, a solution may be found in the knowledgebase on our website at <http://information.networktechinc.com/jive/kbindex.jspa> or please call us directly at **(800) 742-8324 (800-RGB-TECH)** or **(330) 562-7070** and we will be happy to assist in any way we can.

Problem/Message	Cause	Solution
"OUT OF FREQUENCY"	Input signal is outside the supported range	Lower video frequency to be within specified range
"POWER SAVER MODE"	The input signal is not present. This message will disappear after 5 seconds.	Check all cable connections- verify that they are secure
"NO SIGNAL"	The input signal is not present immediately after power ON.	Check all cable connections- verify that they are secure
"AUTO CONFIGURATION"	The LCD monitor is configuring itself for proper communication with the CPU.	No action necessary
Keyboard/touchpad not functioning	<ul style="list-style-type: none"> Keyboard is in the incorrect mode Cables are not properly connected 	<ul style="list-style-type: none"> Toggle the keyboard mode from PS/2 to USB. Check all cable connections between the RACKMUX and the computer.
Keys pressed on the keyboard do not yield the expected result	"Fn" function is locked ON.	Check to see if the Fn LED is illuminated. If so, press the "Fn" key twice quickly to unlock the function.
LCD is not displaying image	<ul style="list-style-type: none"> Image out of range LCD Auto-Shut OFF button is depressed LCD is powered OFF 	<ul style="list-style-type: none"> Lower the resolution Make sure nothing is resting on the button Turn power to LCD ON

INDEX

Alternate command hot key, 37
 Apple Mouse, 41
 autologin, 39
 Autostatus, 45
 baud rate, 39, 43
Broadcast Mode, 29
 cable connections, 7
CAC card reader, 8
 Change password, 34
 Display functions, 13
 Drawer installation, 2
 edit user, 33
 ethernet configuration, 35
 features, 12
 Find Mode, 27
 Firmware upgrade, 50
 forgot password, 30
 Function key, 19
 idle timeout, 36
Java Runtime Environment, 9
 Key Equivalents, 41
 keyboard control, 22
 kvm on IP password, 9
Matrix Switcher's Control Program, 46
 navigating OSD menus, 23
 numeric keypad, 20

OSD, 23
 OSD Controls, 13
OSD Menu-DVI, 15
 Password and User Name, 7, 30
 port configuration, 32
 reset port names, 37, 39, 40
RMTEST, 48
RS232 Command Protocol, 45
RS232 pinout, 43
Scan Mode, 28
 security configuration, 38
 security enable, 38
Security features, 23
Select Language, 38
SerTest, 47
Settings, 26
 Sun's extra keys, 41
 system configuration, 32
 usage statistics, 35
USB port, 8
USB-PS/2 mode, 21
USBVEXT-xx-MM cable, 6
 user access control, 34
 user configuration, 33
 user control methods, 22

WARRANTY INFORMATION

The warranty period on this product (parts and labor) is two (2) years from the date of purchase. Please contact Network Technologies Inc at **(800) 742-8324** (800-RGB-TECH) or **(330) 562-7070** or visit our website at <http://www.networktechinc.com> for information regarding repairs and/or returns. A return authorization number is required for all repairs/returns.

MAN129 Rev. 8/1/13