

## XTENDEX® Series

# ST-C5USBV-1000S ST-C5USBVA-1000S ST-C5USBVU-1000S ST-C5USBVUA-1000S

## HI-RES VGA USB KVM EXTENDERS

With Optional Audio Support and Additional USB Port  
for CAC Card Reader, Touch Screen Monitor, and  
SMART Board™ Interactive Whiteboard

## Installation and Operation Manual



ST-C5USBVUA-1000S  
Remote and Local Units

## TRADEMARK

XTENDEX is a trademark of Network Technologies Inc in the U.S. and other countries.

## COPYRIGHT

Copyright © 2010, 2011 by Network Technologies Inc, all rights reserved. No part of this publication may be reproduced, stored in a retrieval system, or transmitted, in any form or by any means, electronic, mechanical, photocopying, recording, or otherwise, without the prior written consent of Network Technologies Inc, 1275 Danner Drive, Aurora, Ohio 44202. For more information please contact Network Technologies Inc at (800) 742-8324 (800-RGB-TECH) or (330) 562-7070.

## CHANGES

The material in this guide is for information only and is subject to change without notice. Network Technologies Inc reserves the right to make changes in the product design without reservation and without notification to its users.

## Current Firmware Versions

Local Controller Version 1.4

Local Port Controller Version 1.4

Remote Controller Version 1.5.

**Note: CAT5 connection cable used between NTI XTENDEX Series Local and Remote or any XTENDEX Series products should not be run underground, outdoors or between buildings.**



**WARNING: Outdoor or underground runs of CAT5 cable could be dangerous and will void the warranty.**

## Table of Contents

<b>Introduction</b> .....	<b>1</b>
Types of User Input Devices Supported.....	1
Operating Systems Supported.....	2
Limitations.....	2
<b>Materials</b> .....	<b>2</b>
<b>Features and Functions</b> .....	<b>3</b>
<b>Preparation for Installation</b> .....	<b>4</b>
<b>Installation</b> .....	<b>5</b>
The Local Unit.....	5
Connect to the CPU.....	5
Connect the Local Devices.....	6
The Remote Unit.....	7
Connect the CAT5 Cable.....	8
Plug-in and Boot Up.....	9
<b>Configuration and Command Mode</b> .....	<b>10</b>
Command Mode.....	10
Adjust Brightness.....	10
Automatic Video Quality Adjustment.....	10
Fine Video Quality Adjustment.....	11
General Video Quality Adjustment.....	11
Color Skew Adjustment.....	11
Test Patterns.....	11
Update DDC.....	11
Toggle MAC Mode.....	12
Exit Command Mode.....	12
<b>Common Applications</b> .....	<b>13</b>
<b>Firmware Upgrade Procedure</b> .....	<b>14</b>
Requirements.....	14
Prepare to Upgrade the Firmware.....	15
Upgrade Procedures.....	16
Start the Bootloader.....	16
Upgrade the Local Controller Firmware.....	16
Upgrade the Local Port Controller Firmware.....	17
Upgrade the Remote Controller Firmware.....	17
<b>Technical Specifications</b> .....	<b>19</b>
<b>Interconnection Cable Wiring Method</b> .....	<b>20</b>
<b>Keyboard Translation</b> .....	<b>20</b>
Key Equivalents.....	20
SUN's 16 Extra Keys.....	21
<b>Troubleshooting</b> .....	<b>23</b>
<b>Index</b> .....	<b>24</b>
<b>Warranty Information</b> .....	<b>24</b>

## Table of Figures

Figure 1- Connect the Local Unit to a CPU.....	5
Figure 2- Connect local user devices to the Local Unit.....	6
Figure 3- Connect the Monitor and Devices to the Remote Unit.....	7
Figure 4- Connect the CAT5 cable to the Local Unit.....	8
Figure 5- Connect AC adapter to Remote Unit.....	9
Figure 6- MAC Mode LED.....	12
Figure 7- Examples of common applications.....	13
Figure 8- Connect PC for firmware upgrade.....	15
Figure 9- Pin positions in female RJ45 connector.....	20
Figure 10- Keyboard Layouts.....	22

# INTRODUCTION

The ST-C5USBV-1000S HI-RES VGA USB KVM Extender (XTENDEX) is designed to enable the relocation of a monitor, USB keyboard, and USB mouse from a USB CPU or NTI USB KVM switch by as much as 1000 feet via CAT5/5e/6 cable. The option to extend stereo audio speakers, USB touch screen monitor, CAC card reader, or SMART Board is also available. Additionally, all extended components can be connected locally. It is extremely simple to install and has been thoroughly tested to insure reliable performance. Through the use of Category 5/5e/6 shielded or unshielded twisted-pair cable (STP/UTP) it is possible to economically increase the flexibility of a computer system.

## Features

- Allows the placement of a monitor, USB keyboard, and USB mouse in a location where only these parts are needed without having the CPU there too, taking up valuable space and adding to room noise.
- Provides crisp and clear resolution up to 1920 x 1200 /60Hz @ 1000 feet (see chart on page 19)
- Industry-leading ultra-high resolutions up to 2048x1536
- Video quality adjustment is automatic providing optimum image quality for varying lengths of cable. Manual fine adjustments are made via keyboard commands.
- Installation can be between a CPU and devices (keyboard, mouse, and monitor), between a CPU and NTI USB switch, or between a NTI USB switch and devices.
- Allows hot-plugging of keyboards and mice
- DDC2B support for local or remote monitor (user selectable)
- Available with optional stereo audio and/or additional USB port for remote and local user.
  - For the additional USB port on the local unit, connect any type of USB device (fully transparent USB connection)
  - For the additional USB port on the remote unit, use to connect a USB touch screen monitor, CAC card reader, or SMART Board™ Interactive Whiteboard
- Firmware is field upgradeable via serial port (models with additional USB support only)
- USB ports support USB 2.0 (low/full speed) devices

## Models Available:

MODEL	AUDIO SUPPORT	ADDITIONAL USB SUPPORT	FIELD UPGRADEABLE
ST-C5USBV-1000S	N	N	N
ST-C5USBVA-1000S	Y	N	N
ST-C5USBVU-1000S	N	Y	Y
ST-C5USBVUA-1000S	Y	Y	Y

## Types of User Input Devices Supported

- XGA, VGA, and SVGA systems
- All NTI USB switches
- Microsoft, Logitech or Kensington Wheelmouse or Trackball on MAC CPUs with manufacturer's drivers
- USB keyboard with Windows® layout
- USB keyboard with SUN layout
- USB keyboard with MAC layout
- USB Mouse - (up to 3 buttons)
- USB IntelliMouse® (scrollwheel)
- Logitech Cordless Elite Duo keyboard and mouse
- Crystal Vision keyboard with touchpad
- Gyration keyboard and mouse
- NTI USB-PS/2 Adapter
- NTI USB-SUN Adapter
- USB touch screen monitor (models with additional USB support only)
- SMART Board™ Interactive Whiteboard (models with additional USB support only)
- USB CAC card reader (models with additional USB support only)
- NEC Multisync E222W (firmware version 1.5 and later)
- Motorola Symbol LS3408 Bar Code Scanner (firmware version 1.3 and later)
- Smart Podium monitors (tested with ID422W and ID370) (firmware version 1.3 and later)

## Operating Systems Supported

- Windows 95,98
- Windows 2000
- Windows ME
- Window XP
- Windows Vista
- Windows 7
- Linux 7.1 or greater
- Sun-Solaris
- MAC OS 9.1 or greater

## Limitations

- PS/2 devices can be connected to the XTENDEX through an NTI USB-PS/2 adapter, however the translation keys described on page 12 will not function in this application.
- The XTENDEX can be used between a cascable NTI switch and a CPU although the cascading features will not function.

## MATERIALS

Materials supplied with this kit:

- ✓ NTI XTENDEX Local Unit
- ✓ NTI XTENDEX Remote Unit
- ✓ 2-120VAC or 240VAC 50 or 60Hz-5VDC/3A AC Adapters
- ✓ CD with a pdf file of this owner's manual

Models with additional USB support (ST-C5USBVU/C5USBVUA-1000S) also include:

- ✓ 1- DB9 Female-to-RJ45 Female adapter
- ✓ 1- 5 foot RJ45-to-RJ45 CAT5 patch cable

Additional materials may need to be ordered, depending upon the configuration :

- USBVEXT-3/6/10 (15HD Male-to-Female and USB Type A Male-to-Female Extension cable) if the Local Unit will be located further than 15" from the CPU or KVM switch
- CAT5/5e/6 shielded/unshielded twisted-pair cable(s) terminated with RJ45 connectors wired straight thru- pin 1 to pin 1, etc. (see pg. 13 for proper EIA/TIA 568B wiring method)

Contact your nearest NTI distributor or NTI directly for all of your KVM needs at 800-742-8324 (800-RGB-TECH) in US & Canada or 330-562-7070 (Worldwide) or at our website at <http://www.networktechinc.com> and we will be happy to be of assistance.

# FEATURES AND FUNCTIONS

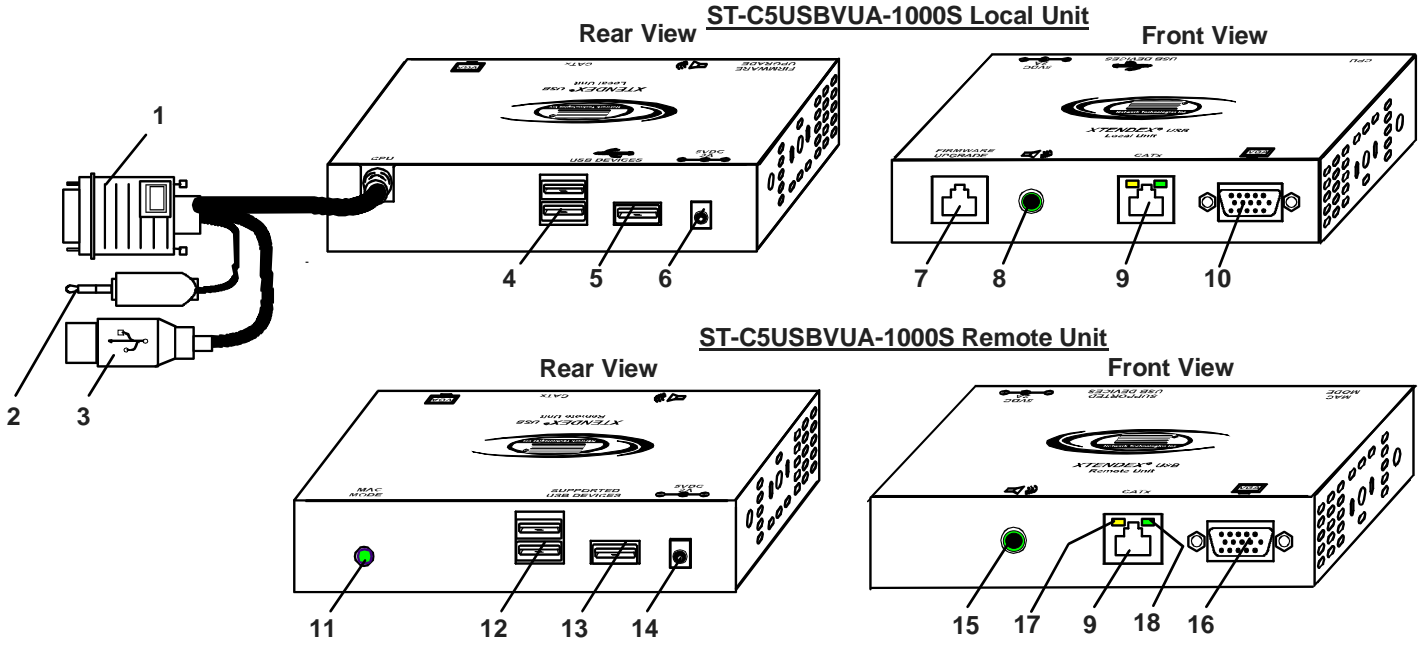

1. **Video Cable**- 15HD male for connection to video connector of CPU
2. **Audio Cable**- 3.5mm plug- for connection to audio connector of CPU
3. **Devices Cable**- USB Type A male connector for connection to CPU
4. **USB DEVICES**- USB Type A female for connection of local user USB device(s)
5. **USB DEVICE**- USB Type A female for local connection of additional USB device (any)
6. **5VDC**- connection jack for Local Unit AC adapter
7. **RS232 Control** - for connection of terminal to update program (models with Additional USB Support only)
8. **Audio Out** ( ) - 3.5mm Stereo Jack- for local connection of self-powered stereo speakers
9. **CATx**- RJ45 female for connection of CAT5/5e/6 cable between Local Unit and Remote Unit
10. **Monitor** ( ) - 15HD female for connection of video cable from local monitor
11. **MAC LED**- for visual indication that the Local Unit is configured for connection to a MAC CPU
12. **USB DEVICES**- USB type A female for connection of remote user USB device(s)
13. **USB DEVICE**- USB Type A female for remote connection touch screen, CAC reader, or SMART Board™ only
14. **5VDC**- connection jack for Remote Unit AC adapter
15. **Audio Out** ( ) - 3.5mm Stereo Jack- for remote connection of self-powered stereo speakers
16. **Monitor** ( ) - 15HD female for connection of video cable from remote monitor
17. **Yellow LED**- traffic indicator- blinks when there is valid communication between the Local and Remote Units.
18. **Green LED**- power indicator- illuminates when power has been supplied to the unit

## PREPARATION FOR INSTALLATION

- A location should be chosen for the monitor, mouse, and keyboard that also has space to mount the Remote Unit within the distance provided by the cables from the monitor, mouse, and keyboard. If extension cables are needed, contact NTI for the cables required. If a local user will be connected, a proper location must be chosen for these devices too.
- The CAT5 cable(s) must be run to the locations where the Remote and Local Units will be placed. Be careful to route the cables away from any sources of magnetic fields or electrical interference that might reduce the quality of the video signal (i.e. AC motors, welding equipment, etc.). **NOTE:** If CAT5 cable is already installed in the wall and there are RJ45 wall outlets, it will be necessary to obtain male-to-male straight through connection cables long enough to reach from the wall outlets to the mounting locations of the Remote and Local Units.
- A properly grounded, polarized, and preferably surge-protected 120V or 240V electrical outlet (depending on the AC adapter being used) must be installed close enough to the mounting location of the Remote Unit and monitor to plug them into.
- All cables should be installed in a fashion that will avoid stress on their connections to the equipment. Extended lengths of cable hanging from a connection may interfere with the quality of that connection. Secure cables as needed to prevent this.
- Properly shut down and disconnect the power of the CPU and monitor. Disconnect the monitor, keyboard, and mouse. If other equipment is involved whose connections are being interrupted, be sure to refer to the instruction manuals for that equipment for proper disconnection and re-connection procedures before proceeding.

**Note:** *CAT5 connection cable used between NTI XTENDEX Series Local and Remote or any XTENDEX Series products should not be run underground, outdoors or between buildings.*



**WARNING:** *Outdoor or underground runs of CAT5 cable could be dangerous and will void the warranty.*

# INSTALLATION

## The Local Unit

### Connect to the CPU

1. Plug the cables of the Local Unit into the back of the CPU. (See Fig. 1.)
  - a) Connect the blue 15HD cable from the Local Unit to the female VGA port on the back of the CPU.
  - b) Connect the USB Type A cable from the Local Unit to a female USB Type A port on the back of the CPU.
  - c) If the extender model includes audio support, connect the 3.5mm stereo plug to the audio port on the back of the CPU.

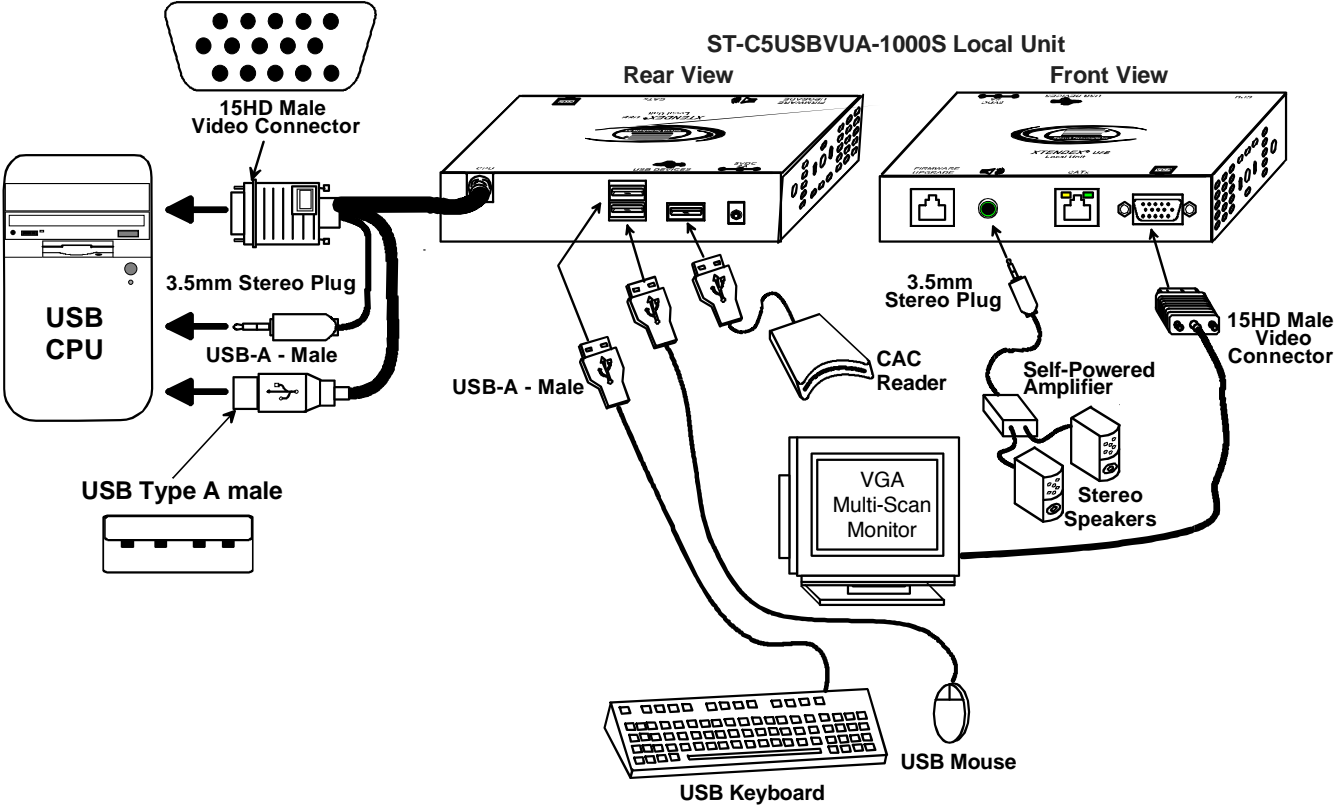



Figure 1- Connect the Local Unit to a CPU



## Connect the Local Devices

If desired, connect the local user devices to the Local Unit as shown in Fig. 2.

1. Connect a USB keyboard and mouse to the USB type A female connectors on the Local Unit.
2. Connect a monitor to the 15HD female connector on the Local Unit.
3. If the unit has audio support, connect self-powered stereo speakers to the audio out port (  ) on the Local Unit.
4. If the unit has additional USB support, connect any USB device (supports USB 2.0 (low/full speed)) to the additional USB type A female connector on the Local Unit.

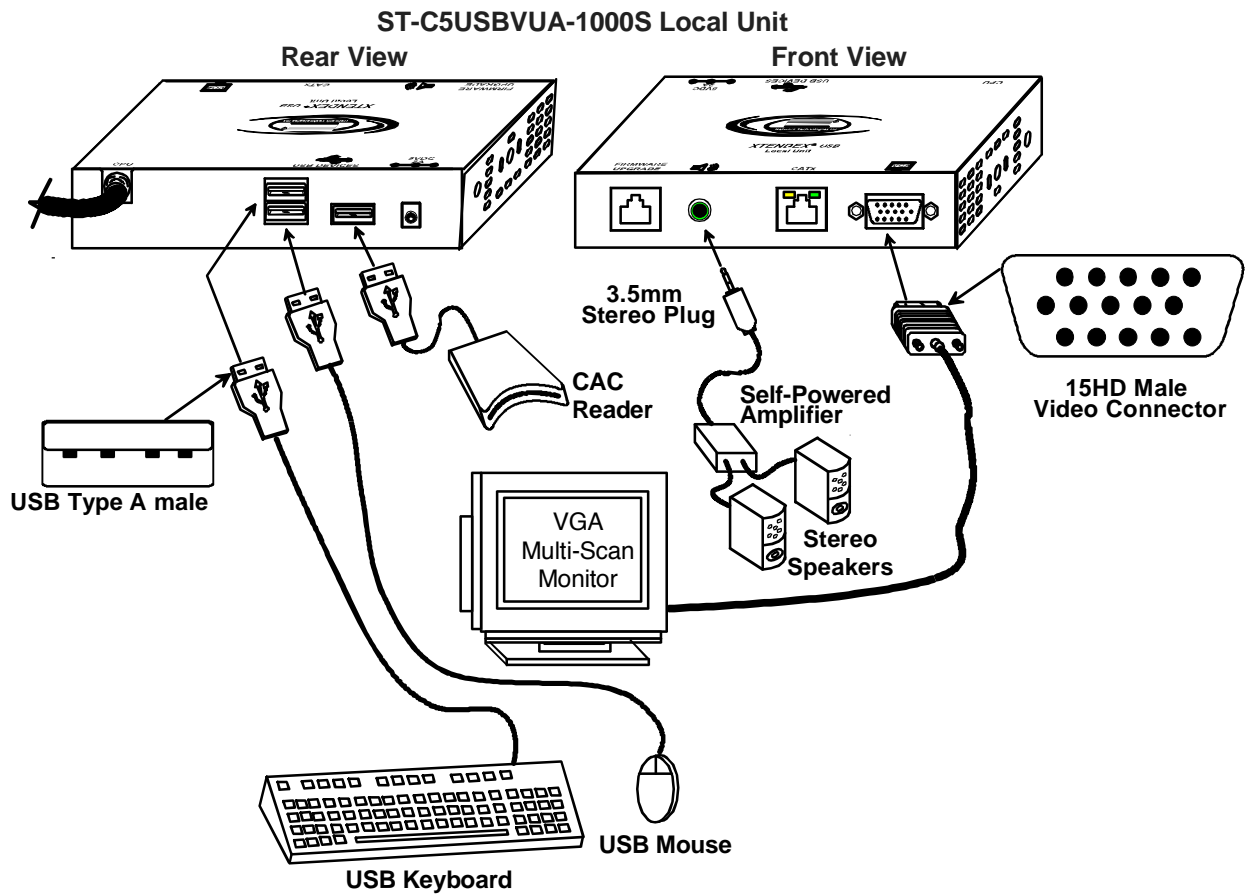



Figure 2- Connect local user devices to the Local Unit

## The Remote Unit

Position the Remote Unit such that each cable to be connected to it can reach the Remote Unit comfortably.

1. Connect a USB keyboard and mouse to the USB type A female connectors on the Remote Unit.
2. Connect the monitor cable to the 15HD female connector on the back of the Remote Unit. (See Fig. 3)
3. If the unit has audio support, connect self-powered stereo speakers to the audio out port (  ) on the Remote Unit.
4. If the unit has additional USB support, connect a CAC card reader, SMART Board™, or the USB serial connector from a touch screen monitor to the additional USB type A female connector on the Local Unit.

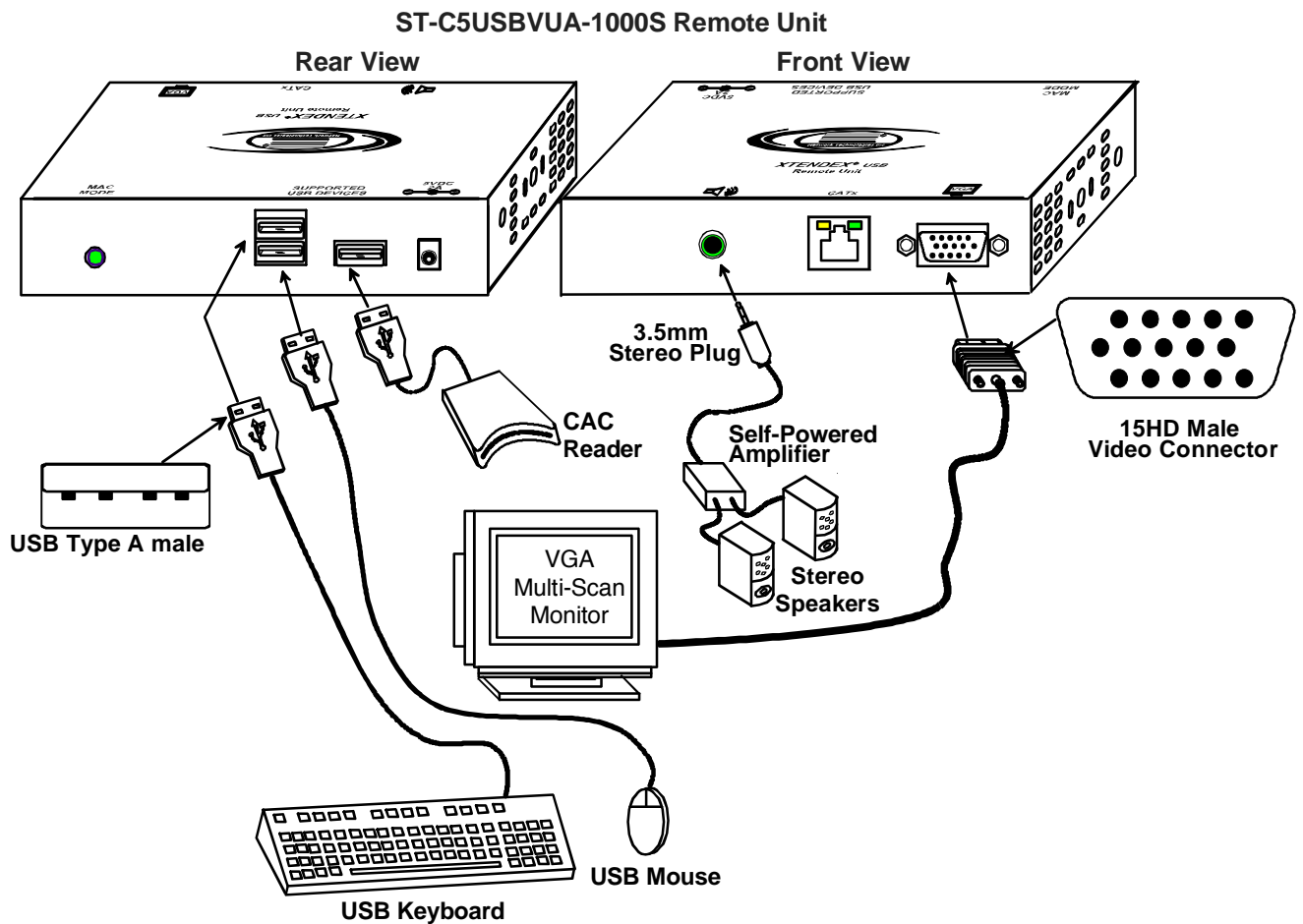

Figure 3- Connect the Monitor and Devices to the Remote Unit

## Connect the CAT5 Cable

Make sure the CAT5/5e/6 cable has been installed in accordance with the "Preparation for Installation" instructions on page 4. Connect one end of CAT5 cable to the "CATx" port on the back of the Remote Unit, and the other end to the "CATx" port on the Local Unit. When properly inserted the CAT5 cable ends should snap into place.



**WARNING:** Never connect the ST-C5USBV-1000S Extender to an Ethernet card, Ethernet router, hub or switch or other Ethernet RJ45 connector of an Ethernet device. Damage to devices connected to the Ethernet may result.

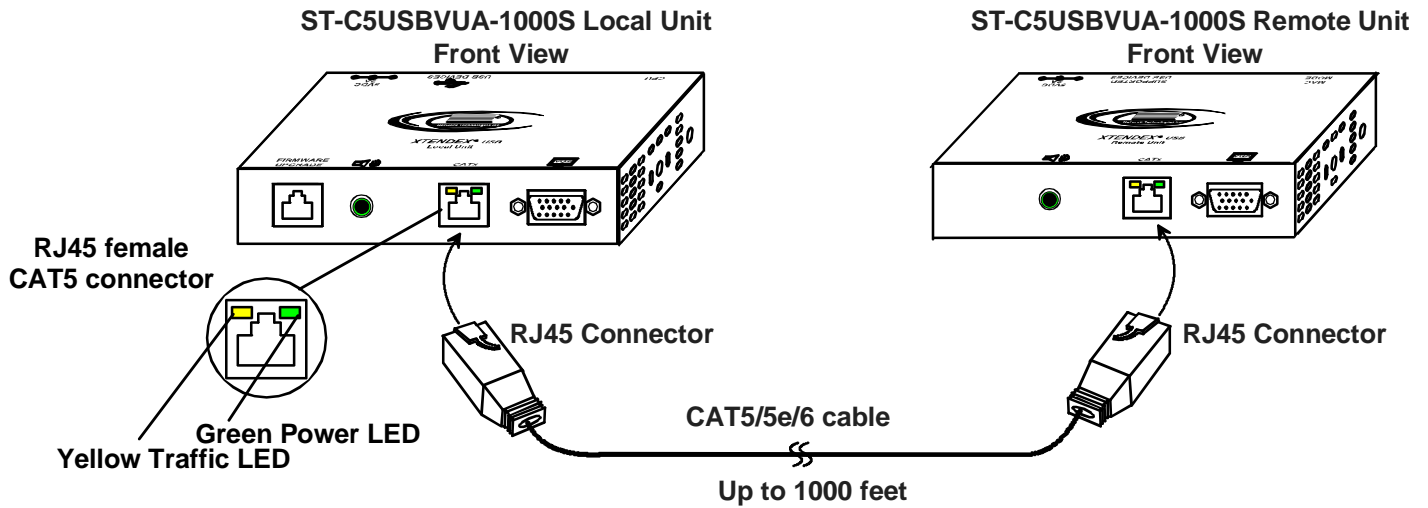

Figure 4- Connect the CAT5 cable to the Local Unit

## Plug-in and Boot Up

1. Plug the power cord from the monitor into the power outlet.
2. Connect one AC adapter power connector to the 5VDC port on the back of the Local Unit. (AC adapter shown in Fig. 5)
3. Plug the AC adapter into a power outlet. The green "Power" LED on the Local Unit should illuminate, indicating that a proper power connection has been made to the Local Unit.
4. Connect the other AC adapter power connector to the 5VDC port on the Remote Unit.
5. Plug the AC adapter into a power outlet. The green "Power" LED on the Remote Unit should illuminate, indicating that a proper power connection has been made to the Remote Unit.
6. Turn ON the monitor, then the CPU. The CPU and monitor should each react as if they were directly connected to each other. The yellow traffic LEDs on the Remote and Local Units (see fig. 3) should blink indicating there is proper communication between them.

**Note: A loss of signal (blank screen) may be experienced for an instant during the auto-compensation process after powering-up. This may also occur if the XTENDEX senses a loss of or weak signal connection in the CAT5 cable.**

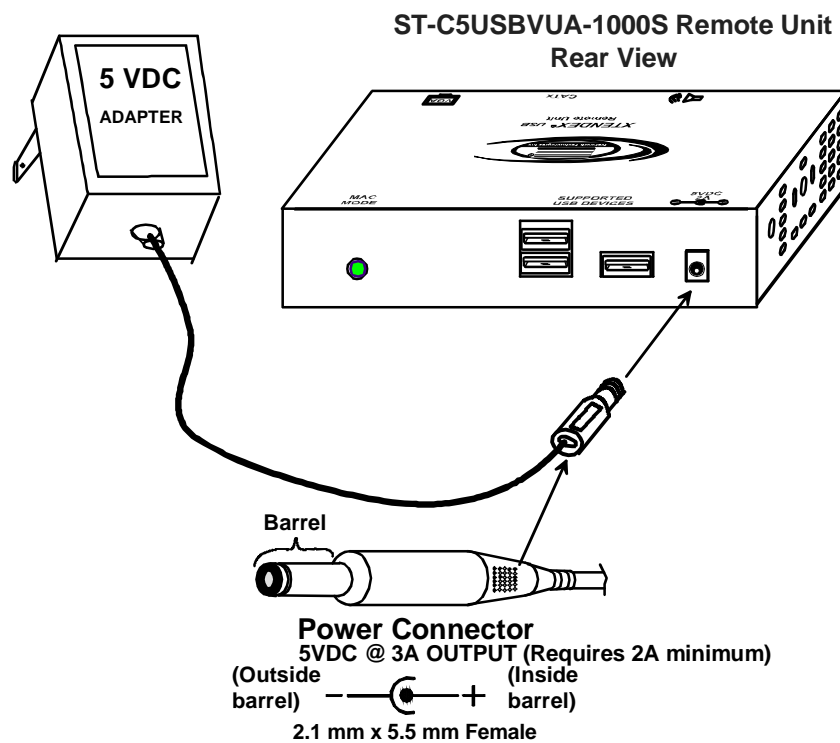

Figure 5- Connect AC adapter to Remote Unit

# CONFIGURATION AND COMMAND MODE

## Command Mode

All models are enabled with a Command Mode feature to perform the following:

- fine adjustment of the general video quality
- fine adjustment of color skew (alignment of red, green, and blue signals on the monitor)
- update DDC information between the monitor(s) and CPU
- toggle between MAC mode and non-MAC mode

Command Mode can be enabled by two keys at the same time; <LEFT SHIFT> + <RIGHT SHIFT>. Press <Esc> at any time to exit Command Mode.

The three keyboard LEDs (NumLock, CapsLock, and ScrollLock) will blink at the same time to indicate entrance into Command Mode.

### Commands available in Command Mode:

Key press	Effect	Extra Control
<Up Arrow>	increases brightness	
<Down Arrow>	decreases brightness	
<A>	forces Auto Video Quality Adjustment	
<Left Arrow>	Decreases fine video adjustment	
<Right Arrow>	Increases fine video adjustment	
<R>	Enable <u>Red</u> Color Skew Adjustment Mode	Use <Left Arrow> or <Right Arrow> to adjust
<G>	Enable <u>Green</u> Color Skew Adjustment Mode	Use <Left Arrow> or <Right Arrow> to adjust
<B>	Enable <u>Blue</u> Color Skew Adjustment Mode	Use <Left Arrow> or <Right Arrow> to adjust
<D>	DDC Update Mode	
<V>	Returns to General Video Quality Adjustment Mode from DDC Update Mode or Color Skew Adjustment Modes	
<M>	Enable MAC Mode	
<W>	Disable MAC Mode	
<Esc>	Exits Command Mode	

## Adjust Brightness

The brightness of the extended image can be increased or decreased by pressing the <Up Arrow> or <Down Arrow> (respectively) while in Command Mode. This adjustment is in addition to any adjustments made possible by controls on your monitor.

## Automatic Video Quality Adjustment

Video quality is broken down into “general video quality” for brightness and sharpness of the images, and “color skew” for how the colors align with each other on the monitor. Both general video quality and color skew adjustments are done automatically any time the XTENDEX is powered ON or if the CATx cable is disconnected and then reconnected. These adjustments can also be forced by pressing the <A> key while in Command Mode.

The automatic video adjustments are calibrated for unshielded twisted pair cable. For shielded cable fine adjustment may be necessary and this can be done from keyboard keys using Command Mode. Video Quality Adjustment settings are automatically stored in the XTENDEX. Settings will be restored each time the XTENDEX is powered-ON. Test patterns for color skew adjustment are provided on the CD.

**Note: If the cable is changed after making manual video adjustments, the XTENDEX will restore these settings to factory default and fine adjustments with the new cable may be necessary.**

## Fine Video Quality Adjustment

### General Video Quality Adjustment

Command Mode opens into General Video Quality Adjustment mode. To fine tune the general video quality, press the <Left Arrow> or <Right Arrow> keys until the desired improvement in the display has been achieved.

### Color Skew Adjustment

If a specific color appears to be skewed and is in need of fine adjustment, the user can switch to Red, Green, or Blue Skew Adjustment mode by pressing <R>, <G> or <B> respectively. The keyboard LEDs will identify the mode as indicated in the table below. Press the <Left Arrow> or <Right Arrow> keys until the desired improvement in the color alignment has been achieved. Press <V> to return to General Video Quality Adjustment mode.

### Test Patterns

To verify the need for and effect of color skew adjustment using a test pattern specifically designed for your display setting, browse the CD this manual was found on and click on the "test-pattern-nXm.pdf" file that matches your current video resolution. Follow the instructions above to make adjustments as needed.

**Note:** For additional quality adjustment, it may be necessary to adjust the brightness and contrast settings of the monitor.

#### Keyboard LEDs Indications:

Adjustment Mode	NumLock	CapsLock	ScrollLock
Command Mode ON	Blink	Blink	Blink
Red Skew	Blink	Solid	Solid
Green Skew	Solid	Blink	Solid
Blue Skew	Solid	Solid	Blink
DDC Update	Off	Solid	Off
Command Mode OFF	Normal state	Normal state	Normal state

### Update DDC

DDC information allows the CPU to automatically select the optimal resolution for your monitor. The procedure to update DDC information (below) must be performed only once at initial setup through Command Mode (provided the monitor is not changed). Both the Local and Remote Units must be powered in order to update the DDC information. The DDC information will be based on the monitor connected to the Remote Unit.

#### To update DDC information (from Command Mode);

1. press <D> to enter DDC Update mode. (See chart above for LED indications.)
2. press the <Left Arrow> + <Right Arrow> keys simultaneously to cause DDC information to be updated  
When the update is complete (less than one second), the three keyboard LEDs will blink at the same time.
3. press <V> to return to General Video Quality Adjustment mode.
4. press <Esc> to exit Command Mode
5. Restart the CPU.

**Note:** It is recommended that the monitors connected to the Remote and Local units be of the same make and model.

**Attention:** Some graphics cards will not send a video signal to the monitor until it has received the DDC information from the monitor. In this case, the monitor may not display anything until the DDC information is read. This may occur if this is the first time the monitor is being connected to the XTENDEX. The DDC information must be updated in the XTENDEX to achieve video using the procedure outlined above.

If the monitor is changed to a different model than was initially installed, the update procedure must be repeated through Command Mode.

## Toggle MAC Mode

MAC Mode enables the user to connect the Local Unit to a MAC CPU. MAC Mode configures the Local Unit for passing mouse information to the MAC CPU. This is useful when the user wants to use mouse drivers provided by the mouse vendor, which allows the use of programmable functions for each mouse button. The Local Unit can be configured whenever necessary.

In the default setting (non-MAC Mode), the XTENDEX is configured for connection to a SUN or Windows CPU. To toggle between non-MAC Mode and MAC Mode, press <M> while in Command Mode. The "MAC Mode" LED on the Remote Unit will illuminate when the XTENDEX is in MAC Mode.

**NOTE: When the port is connected to a PC or SUN CPU, MAC Mode (and the MAC Mode LED) should be OFF.**

To do this;

1. Enter Command Mode. (Simultaneously press the left and right <shift> keys on the keyboard connected to the Remote Unit. The keyboard LEDs will illuminate. )
2. If a MAC CPU is connected, press the <M> key. The keyboard LEDs will momentarily flash and the "MAC" LED on the Remote Unit will illuminate to indicate MAC Mode is ON. (See **Error! Reference source not found.**)

To reconnect the XTENDEX to a SUN or Windows CPU (the default setting) , press the <W> key and the "MAC" LED will go OFF.

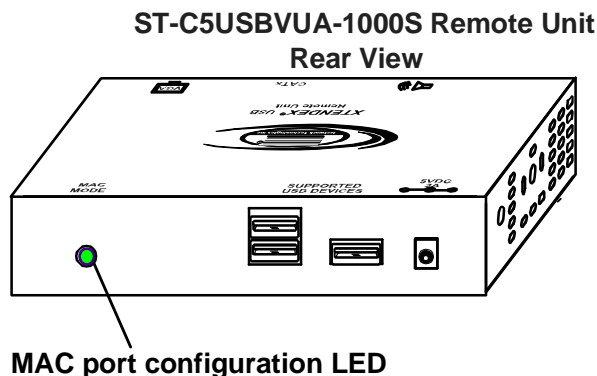

Figure 6- MAC Mode LED

## Exit Command Mode

Press the <Esc> key to exit Command Mode and return to normal operation. All keyboard LEDs will return to current keyboard LED state.

**FYI: Video quality will be limited by several factors. Some factors include the quality and type of CAT5 cable being used, the length of cable run, the quality of the monitor, the resolution setting of the monitor, and the quality of the video card used in the video source. If the desired level of image clarity cannot be achieved by making the adjustments described in this section, consider the following possible adjustments that can be made:**

- Improve the quality of cable used -CAT5,5e,or 6 (CAT5e unshielded (UTP) cable will provide the best performance)
- Use unshielded cable (UTP) instead of shielded cable (STP)
- Shorten the length of the cable between the remote and local
- Reduce the resolution setting on the monitor used
- Use a higher quality video card in the video source

# COMMON APPLICATIONS

Figure 7 (below) illustrates three common applications for the ST-C5USBV-1000S USB KVM Extender.

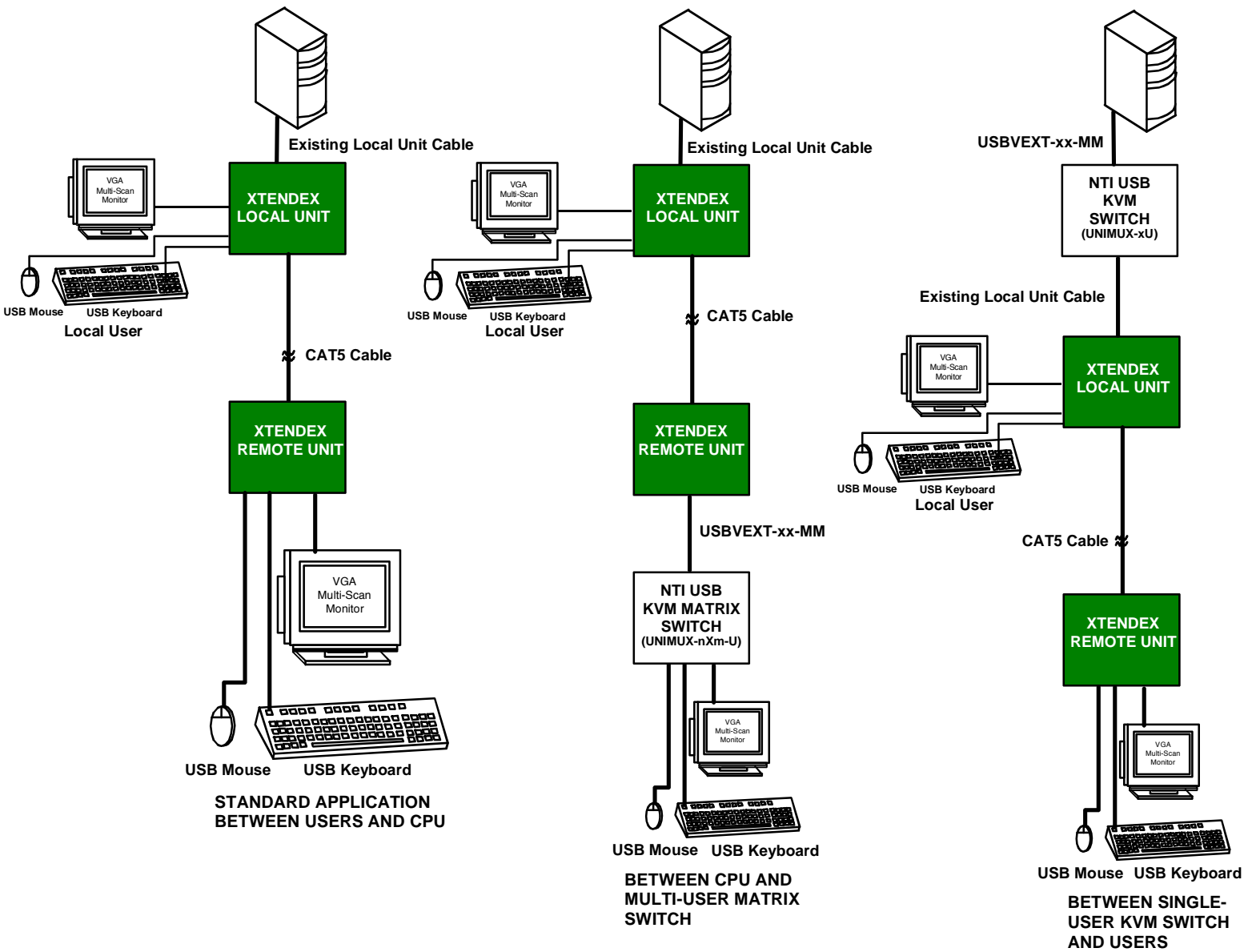

Figure 7- Examples of common applications



## FIRMWARE UPGRADE PROCEDURE

This procedure describes how to upgrade the firmware in this XTENDEX. Only models with Additional USB Support can be upgraded. If you are not certain whether this XTENDEX has the most up-to-date firmware available, simply download the latest version and follow the upgrade procedure. All versions of firmware can be downloaded from <http://www.networktechinc.com/usbkvm.html>.

The XTENDEX has 3 types of micro-controllers:

1. Local Controller – the Local Controller will be upgraded with a binary file named **c5usbvu-lcsx-x.bin**. (where x-x is the rev number)
2. Local Port Controller – the Local Port Controller will be upgraded with a hex file named **c5usbvu-lcpx-x.hex**.
3. Remote Controller – the Remote Controller will be upgraded with a bin file named **uc5usbvu-rctx-x.bin**.

The XTENDEX firmware has a bootloader which can be used for firmware upgrades. The bootloader resides in a protected area of Flash memory, so that if the upgrade fails for any reason, the bootloader will still be available to be used to re-program the entire unit.

Upgrades are made to the Local Controller, Local Port Controller, or Remote Controller separately. Not all Controller firmware is updated with each revision, however it is highly recommended that if you upgrade one piece of firmware, you upgrade each controller segment to make sure your Local and Remote are both at current versions.

### Requirements

- CAT5 Patch Cable (supplied with XTENDEX)
- RJ45-DB9 or DB25 Adapter (supplied with XTENDEX)
- Computer with a Terminal Console (for example, HyperTerminal in Windows, or any similar program able to send files using Xmodem protocol)
- Firmware files for the XTENDEX on the computer with the Terminal Console.

## Prepare to Upgrade the Firmware

With the power to the PC and XTENDEX OFF, connect a PC to the XTENDEX using the supplied 5 foot patch cable and 9DB-to-RJ45 adapter. Connect the patch cable to the "FIRMWARE UPGRADE" port on the Local Unit, attach the supplied 9DB-to-RJ45 adapter to the patch cable, and connect the 9DB adapter to an available COM port on the PC.

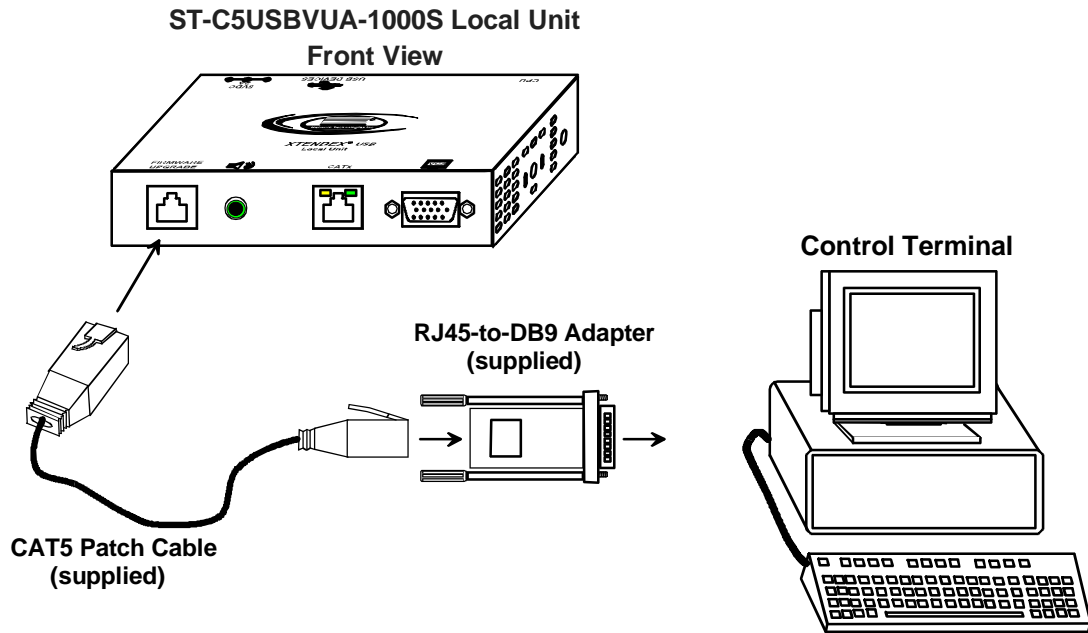

Figure 8- Connect PC for firmware upgrade

2. Power ON the computer only. Open the terminal console and apply the following settings to the terminal console for the port connected to the XTENDEX:

Baud rate: 57600

Data bits: 8

Parity: none

Stop bits: 1

Flow control: none

# Upgrade Procedures

## Start the Bootloader

In the HyperTerminal window on the attached computer, press **and hold** the <Tab> key and power ON the XTENDEX. The following message (or one similar) will be displayed on the screen:

```
ST-C5-USBVA Bootloader
Revision: 1.1
Date: 2010/01/11 15:40:16
Copyright (C) Network Technologies Inc.
```

```
Press <H> for help..
>
```

Release the <Tab> key.

The “>” prompt indicates that the bootloader is waiting for commands. The available commands are composed by sending one ASCII character. To send a command to the bootloader, type the key in the terminal window that corresponds to the desired command. The available commands, listed below, can be viewed by typing <h> or <H> (the Help command) from the keyboard.

**Note: Commands can be typed using upper or lower case letters.**

### **Local Bootloader List of Commands:**

```
h, H - Display list of commands
x, X - Exit Bootloader
u, U - Upgrade Local controller firmware
p, P - Upgrade Local port controller firmware
r, R - Upgrade Remote controller firmware
s, S - Read Checksum of the Local port controller firmware
```

## Upgrade the Local Controller Firmware

The Local controller firmware comes as a file in binary format and has the extension .bin. (i.e. filename.bin). To upgrade the Local controller to this file, press <u> from Terminal window. The following message should appear on the screen:

```
Erasing flash memory..
Memory successfully erased
Send .bin file using Xmodem protocol..
```

At this point the binary file **c5usbvu-lcsx-x.bin** must be sent. To do this, from HyperTerminal:

1. go to “Transfer” menu in the Menu Bar of the HyperTerminal window
2. click the item “Send File ...”
3. in the dialog box which pops up on the screen, browse for the file to be sent and select it
4. select “Xmodem” from the Protocol drop-down menu
5. press “Send” button

The transmission will start shortly. Wait until the transmission is finished. There will be some pauses during transmission, since the processor writes blocks of 4KB.

When the transmission is complete, the HyperTerminal window should show the following status message and return to the menu prompt:

```
Device successfully programmed!
```

```
>
```

To exit from the bootloader, press <x>.

## Upgrade the Local Port Controller Firmware

The Local port controller firmware comes as a file in Intel Hex format and has the extension .hex (i.e. filename.hex). To upgrade any of Local Port controller with this firmware, press <p> from the terminal window. The following message should appear on the screen:

```
Send .hex file using XModem protocol...
```

At this point, the hex format file **c5usbvu-lcp-x.hex** has to be sent, using HyperTerminal and the same procedure as before. When the transmission is done, the following message will be shown in the HyperTerminal window:

```
File transfer OK!  
Please, type <A> to program chip or <X> to exit
```

To program the chip, just press <a>).

The following message will be shown on the screen (it may take about 12 seconds to program):

```
Programming device, please wait...
```

```
Device ID: 0x001E  
Device successfully programmed!
```

To exit from the bootloader, press <x>.

**Note: The Local port controller firmware will rarely, if ever, need to be updated. The firmware download package will include both of the current Local and Remote controller firmware versions, but will only include the Local port controller firmware if it has changed.**

## Upgrade the Remote Controller Firmware

The Remote controller firmware comes as a file in binary format and has the extension .bin. (i.e. filename.bin). To upgrade the Remote controller to this file, press <r> from Terminal window. The following message should appear on the screen:

```
The Local Unit bootloader will now pass control  
to the Remote Unit bootloader  
Please, check that the Remote Unit is powered off  
Please, type <Y> to continue or <X> to cancel
```

If you type <Y> to continue you get the following message:

```
To enter into Remote Unit bootloader, power on the unit  
while keeping the <TAB> key pressed
```

### **Remote Bootloader List of Commands:**

```
h, H - Display list of commands  
x, X - Exit Bootloader  
r, R - Upgrade Remote controller firmware
```

To proceed to upgrade the Remote controller, press <r> from Terminal window. The following message should appear on the screen:

```
Erasing flash memory..  
Memory successfully erased  
Send .bin file using Xmodem protocol..
```

At this point the binary file **c5usbvu-rcsx-x.bin** must be sent. To do this, from HyperTerminal:

1. go to "Transfer" menu in the Menu Bar of the HyperTerminal window
2. click the item "Send File ..."
3. in the dialog box which pops up on the screen, browse for the file to be sent and select it
4. select "Xmodem" from the Protocol drop-down menu
5. press "Send" button

The transmission will start shortly. Wait until the transmission is finished. There will be some pauses during transmission, since the processor writes blocks of 4KB.

When the transmission is complete, the HyperTerminal window should show the following status message and return to the menu prompt:

**Device successfully programmed!**

>

To exit from the bootloader, press <X>.

## TECHNICAL SPECIFICATIONS

Video Compatibility	SVGA, XGA, VGA
Video Quality	Variable for up to 1000 feet of CAT5 cable
Video Coupling	DC
Video Connectors	HD15 male to CPU HD15 female to local and remote monitors
Sync Types Supported	Separate and composite TTL Level and sync on green
Video Signal Type	Analog RGBHV, RGBS, RGsB
Maximum Input/Output Levels	1.45Vp-p (no offset)
Input / Output Impedance	75 Ohms
Input Horizontal Frequency Range	15kHz to 150 Hz
Input Vertical Frequency Range	30 Hz to 150 Hz
Keyboard/Mouse Connectors	USB Type A female- to local and remote keyboard/mouse USB Type A male- to CPU
Interconnect Cable	CAT5/5e/6 Solid UTP/STP EIA/TIA 568B wiring w/ male RJ45 connectors
Remote and Local Unit Power	120V or 240V (50 or 60Hz) 5VDC/2.0A AC Adapters
Operating Temperature	32°F to 100°F (0°C to 38°C)
Storage temperature	-20°F to 140°F (-30°C to 60°C).
Operating and Storage Relative Humidity	17 to 90% non-condensing RH
ESD protection	Complies with EN61000-4-2 Specification
Dimensions WxDxH (In.)	5.1x3.1x1.2
<b>Models with Additional USB Support</b>	
Devices Supported Local Unit Remote Unit	Any USB 2.0 (low/full speed) devices Limited USB 2.0 low/full speed devices (USB SMART Board, CAC Card Reader, Touch screen Monitor)
<b>Models with Stereo Audio Support</b>	
Audio Connectors	3.5mm stereo jack (lime) to speakers 3.5mm stereo plug (lime) to CPU
Signal Type	Line Level, stereo, unbalanced
Audio Frequency Response	20Hz to 20kHz, ± 1dB
Signal-to-Noise Ratio	>76 dBA
Stereo Crosstalk	-70 dB @ 1kHz
Audio Maximum I/O Levels	3.1Vp-p
Maximum Load	2k Ohms, unbalanced
Input Impedance	10k Ohms
Total Harmonic Distortion and Noise	0.017%, F=20-20KHz, RL=2K Ohm, Vout=1 Vrms

### Distances and Maximum Supported Resolutions for CAT5, CAT5e and CAT6 Cables

#### Unshielded Twisted Pair (UTP) Resolutions

UTP CABLE	DISTANCE (feet)	RESOLUTION
CAT5/5e	1000	1920x1200 at 60Hz
CAT5/5e/6	800*	1920x1440 at 60Hz
CAT5/5e/6	600	2048x1536 at 60Hz

\*The performance of CAT6 unshielded, is not guaranteed beyond 800 feet.

#### Shielded Twisted Pair (STP) Resolutions

STP CABLE	DISTANCE (feet)	RESOLUTION
CAT5/5e	800**	1920x1200 at 60Hz
CAT5/5e	600	1920x1440 at 60Hz
CAT5/5e	400	2048x1536 at 60Hz
CAT6	400**	1280x1024 at 60Hz
CAT6	300	1600x1200 at 60Hz
CAT6	200	2048x1536 at 60Hz

\*\*The performance of CAT5 and CAT5e shielded cable is not guaranteed beyond 800 feet (400 feet for CAT6 shielded).

## INTERCONNECTION CABLE WIRING METHOD

The connection cable between the remote and local is terminated with RJ45 connectors and must be wired according to the EIA/TIA 568B industry standard. Wiring is as per the table and drawing below.

Pin	Wire Color	Pair	Function
1	White/Orange	2	T
2	Orange	2	R
3	White/Green	3	T
4	Blue	1	R
5	White/Blue	1	T
6	Green	3	R
7	White/Brown	4	T
8	Brown	4	R

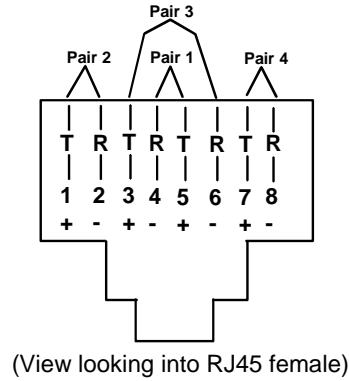

**Figure 9- Pin positions in female RJ45 connector**

**Note:** CAT5 connection cable used between NTI XTENDEX Series Local and Remote or any XTENDEX Series products should not be run underground, outdoors or between buildings.



**WARNING:** Outdoor or underground runs of CAT5 cable could be dangerous and will void the warranty.

## KEYBOARD TRANSLATION

### Key Equivalents

Using the chart below, find the character needed to be typed on the CPU being accessed, then follow the row across for the equivalent on the keyboard being used. (See Fig. 11 on page 22 for reference.)

USB 101	WINxx	MAC (Apple USB)	SUN
L-Ctrl	L-Ctrl	L-Ctrl	L-Ctrl
L-Alt	L-Alt	L-Option	L-Alt
SB+F12	Application	SB+F12	Compose
R-Alt	R-Alt	R-Option	Alt-Graph
SB+Alt	Windows Logo	Command	Meta
SB+R Arrow	SB+R Arrow	Power	Suspend

SB = Space Bar

L and R = Left and Right keys when two keys are marked the same on a keyboard.

## SUN's 16 Extra Keys

Use the chart below to type SUN's additional 16 keys using a 101, WINxx, or MAC (Apple) USB keyboard).

101,WINxx,MAC Keyboards	SUN Extras	101,WINxx,MAC Keyboards	SUN Extras
SB+F1	Stop (L1)	SB+F9	Find (L9)
SB+F2	Again (L2)	SB+F10	Cut (L10)
SB+F3	Props (L3)	SB+F11	Help
SB+F4	Undo (L4)	SB+F12	Compose
SB+F5	Front (L5)	SB + Up Arrow	Vol +
SB+F6	Copy (L6)	SB + Down Arrow	Vol -
SB+F7	Open (L7)	SB + L Arrow	Mute
SB+F8	Paste (L8)	SB + R Arrow	Suspend

SB = Spacebar



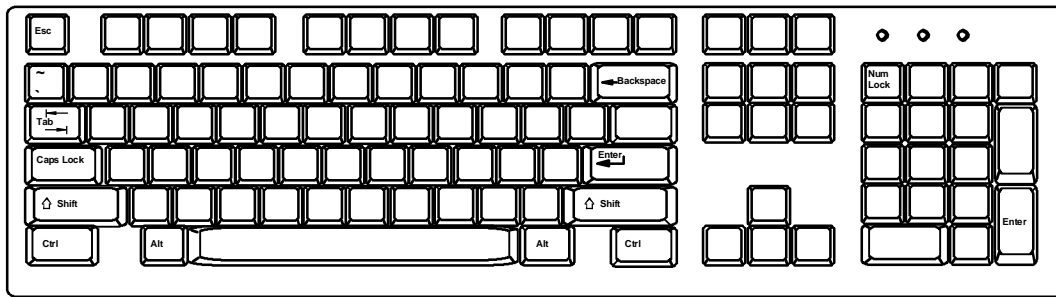

Typical 101 Keyboard

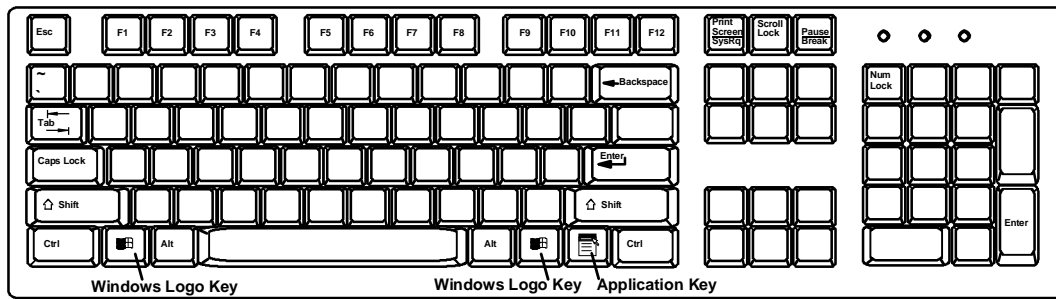

Windows USB Keyboard

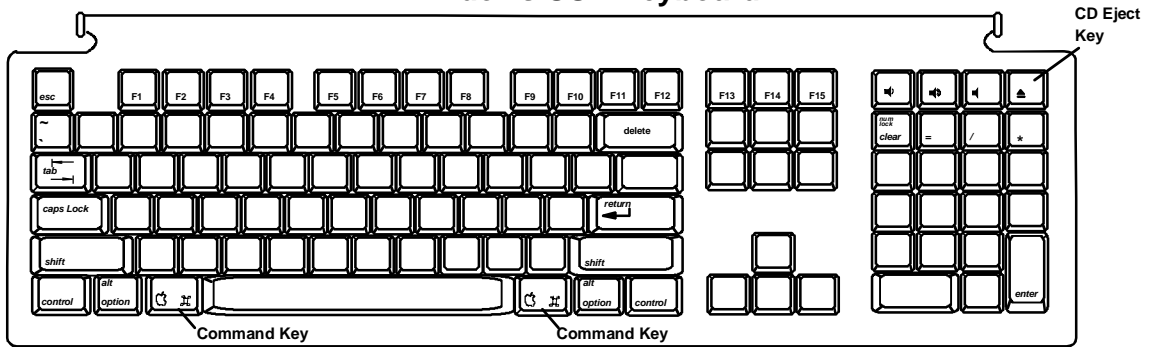

Apple Pro USB Keyboard



SUN USB Keyboard

Figure 10- Keyboard Layouts

## TROUBLESHOOTING

Each and every piece of every product produced by Network Technologies Inc is 100% tested to exacting specifications. We make every effort to insure trouble-free installation and operation of our products. If problems are experienced while installing this product, please look over the troubleshooting chart below to see if perhaps we can answer any questions that arise. If the answer is not found in the chart, please check the FAQs (Frequently Asked Questions) at our website at <http://www.networktechinc.com> or contact us directly for help at 1-800-742-8324 (800-RGB-TECH) in US & Canada or 1-330-562-7070. We will be happy to assist in any way we can.

<b>Problem</b>	<b>Cause</b>	<b>Solution</b>
<b>Remote Unit power LED does not illuminate</b>	<ul style="list-style-type: none"> <li>Power supply is not connected or plugged-in.</li> </ul>	<ul style="list-style-type: none"> <li>Make sure outlet is live and transformer is plugged-in.</li> <li>Make sure 5VDC jack is fully connected to the Remote Unit.</li> </ul>
<b>Local Unit power LED does not illuminate</b>	<ul style="list-style-type: none"> <li>Local is not connected to CPU.</li> </ul>	<ul style="list-style-type: none"> <li>Make sure proper connection is made to CPU.</li> </ul>
<b>No video on monitor</b>	<ul style="list-style-type: none"> <li>One or more video cables is loose or disconnected.</li> <li>No Power to Remote or Local Units.</li> <li>Video Cable was not attached when CPU was booted.</li> <li>CAT5 cable is not connected.</li> <li>DDC Information needs to be updated in CPU</li> </ul>	<ul style="list-style-type: none"> <li>Check all video cable connections</li> <li>Make sure power LED is illuminated for local and remote. If not, see both solutions above.</li> <li>With all the cables properly connected, reboot the CPU.</li> <li>Check cable connections. Make sure they are snapped-in properly and completely.</li> <li>Check cable connections. Make sure they are snapped-in properly and completely.</li> <li>See "Update DDC" on page 11.</li> </ul>
<b>Video picture is not sharp or is smeared</b>	<ul style="list-style-type: none"> <li>All Video Cables are not firmly seated.</li> <li>CAT5 cable is too long.</li> <li>The CAT5 cable is not properly connected.</li> <li>Video quality is not set properly.</li> </ul>	<ul style="list-style-type: none"> <li>Check all connections. Make sure all cables are fully seated.</li> <li>Verify length is within specified limits-1000' max.</li> <li>Check cable connections. Make sure they are snapped-in properly and completely.</li> <li>See pg. 9 for instruction on "Video Quality Adjustment".</li> </ul>
<b>Monitor sometimes loses sync, causing it to go blank for a second or two</b>	<ul style="list-style-type: none"> <li>Electrical power system is very noisy, particularly the ground.</li> <li>The CAT5 cable is not properly connected.</li> </ul>	<ul style="list-style-type: none"> <li>Make sure the interconnection cable is not near any power lines.</li> <li>Check cable connections. Make sure they are snapped-in properly and completely.</li> </ul>
<b>The picture on the monitor is black and white, rather than color</b>	The video cable was not attached to the CPU when it was booted.	With the cables all properly connected, reboot the CPU.
<b>A constant vertical wobble appears down the screen</b>	CAT5 cable is too close to a strong power source.	Reroute CAT5 cable if possible.
<b>PC boots with no error messages, but the keyboard does not work</b>	<ul style="list-style-type: none"> <li>Keyboard cable is loose.</li> <li>Keyboard in use is not compatible.</li> </ul>	<ul style="list-style-type: none"> <li>Reseat Keyboard cable and check again.</li> <li>Make sure Keyboard is directly connected, not through a PS/2 to USB adapter.</li> </ul>
<b>Wrong or missing characters from those typed</b>	The keyboard may be in the wrong mode.	<ul style="list-style-type: none"> <li>Disconnect keyboard at Remote Unit end and reconnect.</li> <li>Reboot the system.</li> </ul>
<b>Connecting the keyboard effects the video</b>	Older keyboards may require higher current than our unit supplies.	Change to a newer keyboard.
<b>Mouse cursor appears on the screen, but the mouse does not work</b>	<ul style="list-style-type: none"> <li>Mouse cable is loose or disconnected.</li> <li>Mouse is not compatible.</li> <li>Remote connections didn't initialize.</li> </ul>	<ul style="list-style-type: none"> <li>Check for quality cable connections to mouse at Remote Unit end.</li> <li>Make sure mouse is USB type.</li> <li>Power down the Remote Unit and then power up again.</li> </ul>

## INDEX

bootloader, 16  
brightness control, 10  
cable pinout, 20  
color skew, 11  
**Command mode**, 10  
configuration, 10  
connect the CATx, 8  
connect the local, 5  
connect the remote, 7  
**DDC**, 11  
devices supported, 1  
**features**, 3  
**Firmware upgrade**, 14  
key equivalents, 20  
**MAC mode**, 12  
models available, 1  
preparation, 4  
specifications, 19  
test patterns for skew, 11  
troubleshooting, 23  
Video quality adjustment, 10

## WARRANTY INFORMATION

The warranty period on this product (parts and labor) is two (2) years from the date of purchase. Please contact Network Technologies Inc at (800) 742-8324 (800-RGB-TECH) or (330) 562-7070 or visit our website at <http://www.networktechinc.com> for information regarding repairs and/or returns. A return authorization number is required for all repairs/returns.

**Note:** *CAT5 connection cable used between NTI XTENDEX Series Local and Remote or any XTENDEX Series products should not be run underground, outdoors or between buildings.*



**WARNING:** *Outdoor or underground runs of CAT5 cable could be dangerous and will void the warranty.*

Man063 Rev 6/20/11